



MJB - Gateway User manual

Contents

| | |
|---|----|
| Preface | 3 |
| Important information | 4 |
| Safety instructions | 4 |
| Residual risk | 5 |
| Before installation, reinstallation or troubleshooting | 6 |
| Before start-up | 6 |
| During operation | 6 |
| Information on the MJB | 6 |
| Repairs | 7 |
| Misc. on the MJB system | 8 |
| Warranty and service life | 8 |
| Maintenance | 8 |
| MJB - GATEWAY variant | 9 |
| Standard functionality | 9 |
| Relay 1 and 2 | 9 |
| Features | 11 |
| Options (speciale article) | 11 |
| Usage | 11 |
| Precautions | 12 |
| IP Protection degree | 14 |
| Environmental conditions | 15 |
| Modular plug with wide and narrow slit | 16 |
| Keys to symbols | 17 |
| Drawing appendix | 19 |
| Addresses | 24 |

Preface

Dear User,

We are delighted that you have chosen a product from LINAK®.

LINAK systems are high-tech products based on many years of experience in the manufacture and development of actuators, electric control boxes, controls and chargers.

This User Manual does not address the end-user. It is intended as a source of information for the manufacturer of the equipment or system only, and it will tell you how to install, use and maintain your LINAK electronics. It is the responsibility of the manufacturer of the end-use product to provide a User Manual where relevant safety information from this manual is passed on to the end-user.

We are sure that your LINAK product/system will give you many years of problem-free operation.

Before our products leave the factory they undergo full function and quality testing. Should you nevertheless experience problems with your LINAK product/system, you are always welcome to contact your local dealer.

LINAK subsidiaries and some distributors situated all over the world have authorised service centres, which are always ready to help you.

LINAK provides a warranty on all its products. This warranty, however, is subject to correct use in accordance with the specifications, maintenance being done correctly and any repairs being carried out at a service centre, which is authorised to repair LINAK products.

Changes in installation and use of LINAK products/systems can affect their operation and durability. The products are not to be opened by unauthorised personnel.

The User Manual has been written based on our present technical knowledge. We are constantly working on updating the information and we therefore reserve the right to carry out technical modifications.

LINAK A/S

Important information

Description of the various signs used in this manual.



Warning!

Failure to comply with these instructions may result in accidents involving serious personal injury.



Failing to follow these instructions can result in the product being damaged or destroyed.

Safety instructions



Safe use of the system is possible only when the operating instructions are read completely and the instructions contained are strictly observed.

Failure to comply with instructions marked with the "NOTE" symbol may result in serious damage to the system or one of its components.

Persons who do not have the necessary experience or knowledge of the product/ products must not use the product/ products. Besides, persons with reduced physical or mental abilities must not use the product/products, unless they are under surveillance or they have been thoroughly instructed in the use of the apparatus by a person who is responsible for the safety of these persons.

Moreover, children must be under surveillance to ensure that they do not play with the product.



It is important for everyone who is to connect, install, or use the systems to have the necessary information and access to this User Manual.



If there is visible damage to the product it must not be installed.



The appliance is not intended for use by young children or infirm persons without supervision.



Young children should be supervised to ensure that they do not play with the appliance.



Residual risk

Some of the products contains software based components. LINAK has made various possible efforts to assure that the software is free of errors and that the software has been developed according to the rules of IEC 60601-1-4 (software in Medical products). That involves Risk Analysis which shows a small residual risk for unwanted/unintended movement of actuators under specific conditions.

According to the above rules it must be informed and if necessary considered in the Risk analysis of the final application - More details to residual risk can be provided by LINAK if necessary.

**Warning!**

The plastic parts in the system cannot tolerate cutting oil.

**Warning!**

LINAK's actuators and electronics are not constructed for use within the following fields:

- Planes and other aircrafts
- Explosive environments
- Nuclear power generation

**Warning!**

If faults are observed, the products must be replaced.

**Warning!**

Never spray directly on the products with a high-pressure cleaner.

**Warning!**

Always insure that the patient is accessible in case of emergency.

**Warning!**

Cables must be secured safely so that persons cannot get trapped in it.

**Warning!**

Always use locking mechanism and O-ring

**Warning!**

Sockets not used must be fitted with blind plugs to ensure IP degree



The LINAK products cannot tolerate the influence of strong solvents, basic or alkaline liquids.

**Precautions:**

- Please note, the MJB with SMPS is using 150 mA on V permanent 40V. This means that the remaining current on the V Permanent 40V is 50 mA.
- Some electronically device is only to be used together with 4 Watt version, like for instance Ipod
- Ipod types which can be connected = Nano, Iphone, ??
- There can be a risk of conflict with other accessories, like HB, ACP, SLS etc. it is recommended to make a system overview.

Cable ordering nos.:

USB cable to be used, 0834000-1000

Modular plug cable with open end, 00xxxxx-1000

Before installation, re-installation, or troubleshooting

- Stop the application
- Switch off the power supply and pull out the mains plug.
- Relieve the application of any loads, which may be released during the work.

Before start-up

- Make sure that the system has been installed as instructed in the User Manual.
- Make sure that the voltage of the control box is correct before the system is connected to the mains.
- System connection. The individual parts must be connected before the control box is connected to the mains.

During operation

- Ensure that the cables are not damaged.
- Unplug the mains cable on mobile equipment before it is moved.

Information on the MJB

The MJB Modular Junction Box is designed for use together with OpenBus™ control boxes. The MJB makes it possible to connect multiple handsets, attendant controls or it makes it possible to use the MJB as a control unit for 3rd party products as Out of Bed detection, USB charger, Under Bed Light etc.



LINAK A/S delivers only the OpenBus system and is not responsible for any products other than LINAK products (i.e. products from 3rd party suppliers) or the compliance of such products with the LINAK OpenBus™ system.

Repairs

In order to avoid the risk of malfunction, all repairs must only be carried out by authorised LINAK workshops or repairers, as special tools must be used and special gaskets must be fitted. Products under warranty must also be returned to authorised LINAK workshops.



Warning!

If any of the LINAK products are opened, there will be a risk of subsequent malfunction.

Disposal of LINAK's products

LINAK's products may be disposed of, possibly by dividing them into different waste groups for recycling or combustion.

We recommend that our product is disassembled as much as possible at the disposal and that you try to recycle it. As an example of main groups within sorting of waste we can mention the following:

Metal, plastic, cable scrap, combustible material and collection for recoverable resources.

Some of these main groups can be sub-divided into groups e.g. metal can be divided into iron, stainless steel and aluminium and alloy steel. Plastic can e.g. be divided into ABS, PA, PE and PP.

The MJB can be disassembled and sorted into the following recycling groups:

| Component | Recycling group |
|-----------|---|
| MJB | Plastic housing – Plastic recycling or combustion |
| | Cable – Cable scrap or combustion |
| | PC-board – Electronics scrap |

By now all our casted plastic units are provided with an interior code for plastic types and fibre contents, if any.

Misc. on the MJB system

Warranty and service life

The LINAK warranty covers manufacturing defects in the products, starting from the date of manufacture. There is 18 months' warranty for MEDLINE and CARELINE products. The warranty is limited to the value of the LINAK product.

LINAK's guarantee is only valid so far as the products have been used and maintained correctly and has not been tampered with. Furthermore, the products must not be exposed to violent treatment. In the event of this, the warranty will be ineffective / invalid. LINAK's warranty is only valid if the system is unopened and has been used correctly.

All LINAK products are designed to have an optimum service life as a matter of course, but the expected service life in a specific application is very dependent on how the products are used.

Maintenance

- The LINAK products must be cleaned at regular intervals to remove dust and dirt and inspected for mechanical damage, wear and breaks.
- The LINAK MJB is a closed unit and requires no internal maintenance.
- IPX6 is waterproof.
- Make sure that the plugs in the MJB are correctly fitted with O-rings before washing.
- Electronics must be inspected at attachment points, wires, cabinet, and plugs.
- Inspect the connections, cables, cabinet and plugs, and check for correct functioning.

MJB - GATEWAY variant, 504-010 & 504-020 :

The MJB is a simple gateway interface, which can connect switch input notifications from the infrastructure of the hospital or nursing home, such as service/nurse call systems.

Please note that notifications are only to be used as service information and not for emergency issues.

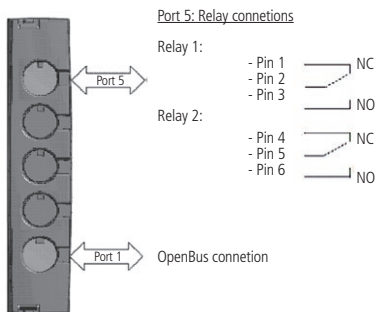

Standard functionality:

The MJB - Gateway consist of two relays, which are connected through Port 5 on the MJB. This can be made with the special cable 0964140 (Modular plug - Open end) There are as standard 2 configurations, 504-01 and 504-02, see description on the next pages.

Relay 1: NC (normally closed) = Pin 2 + Pin 1 / NO (normally open) = Pin 2 + Pin 3

Relay 2: NC (normally closed) = Pin 5 + Pin 4 / NO (normally open) = Pin 5 + Pin 6

Relay 1 is NO when connected to the mains and NC when no mains, this means the relay is "active", when connected to the mains (closed loop). The Closed Loop principal is to ensure that a notification is sent if power is missing on the bed. When the mains is disconnected (power is missing), the relay will go from NO to NC, which will automatically result in a notification (status indicator) on the OpenBus™.

Relay 1 can be activated via the patient control (Key 1 / Key 4) or the attendant control (Key 2 / Key 3). When a key is activated, the relay will switch state from NO to NC for 2 seconds. After 2 seconds the relay will automatically change state from NC to NO.

The status of the relay is indicated on the OpenBus™ and can be used for switching on an LED.

Relay 2 is as default NC, with or without mains, (Open Loop)

Relay 2 can be activated via the patient control (Key 1) or the attendant control (Key 2 / Key 3).

When the relay is activated, it will switch from NC to NO for 2 seconds. After 2 seconds the relay will automatically change state from NO to NC.

The status of the relay is indicated on the OpenBus™ and can be used for switching on an LED.

By using the variant 504-020 relay 2 will be controlled by the MJB variant 505/506 with switch input. Notification 1 = Switch input S2 / notification 2 = Switch input S1

When using this combination, is it important to have the MJB 505/506 connected to the system all the time. If it is not connected, the Gateway MJB will see it as a notification and the relay will be activated.

The Gateway MJB is "scanning" the OpenBus™ system every minute for a notification.

| Relay 1 | | |
|--|-----------------------|-------------|
| CB power mode | Notification level | Relay state |
| Mains unplugged, CB is in power down or the OpenBus™ is not running (Clock/ data is missing) | Notification | NC* |
| On mains or battery at "wake up" | Bed notification \ ** | NC |
| | No notification | NO |

| Relay 2 | | |
|--|-----------------------|-------------|
| CB power mode | Notification level | Relay state |
| Mains unplugged or CB is in power down | No notification | NC |
| On mains or battery at "wake up" | Bed notification \ ** | NO |
| | No notification | NC |

* When the mains is unplugged or CB is in power down will the relay shift to NC state and generate notification.

** Notification generated by nurse call or bed notifications.

Features:

- Add-on value for hospital & care bed
- Compact and functional design which allows easy mounting
- 2 connections, Port1 OpenBus™ connection / Port 5 Gateway
- Colour: Light grey RAL 7035
- Protection class IPX6
- Connection to OpenBus™ control box via modular plug cable, 6 wires
- Modular plug to Open end, see precautions.

Options (special article):

- Customised configuration (Configuration number ≥ 100)
- It is possible to define the OpenBus™ signals to be used for activating the relays and / or change the notification indicator, so that it fits to the customer's system.
Please contact your Sales Engineer at LINAK A/S for further information.

Usage:

- Compatible with all LINAK OpenBus™ Control Boxes, light & full.
- Contact rating :
 - Max continuous current: = 1A
 - Max switching voltage: = 48 V (DC)
 - Max switching capacity: = 24 VA
 - Contact resistance: < 100 m Ω
- Current consumption:
 - V bus 8V : < 9 mA
 - V permanent 40V : < 14 mA
- Approvals: IEC60601-1, ANSI/AAMI ES60601-1 and CAN/CSA-22.2 No 60601-1

Example of closed loop:

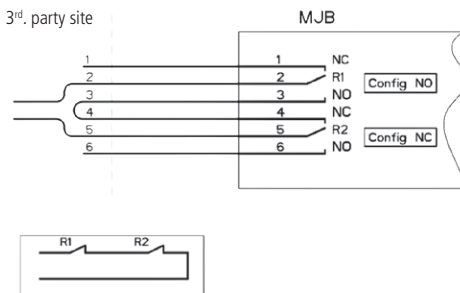

In this state no notification

Example of Open Loop:

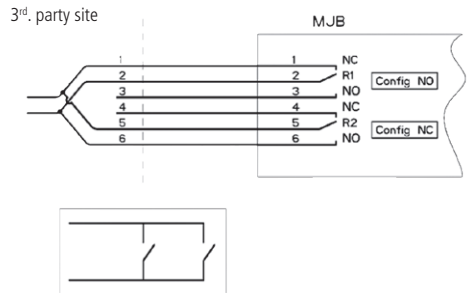

In this state no notification



Recommendations:

- Always use locking mechanism and O-ring
- Sockets not used must be fitted with blind plugs to ensure IP Degree
- When using the modular plug with open end, it is up to the customer to maintain the IP degree.
- If the MJB – Gateway is used as open loop, there is a risk of not sending a notification, when no mains are connected. The MJB – Gateway will only send a notification if mains is missing, when using a Closed Loop (see functionality description.)
- When the Gateway is used on a system with battery, the gateway functionality will follow the power down mode of the control box, see table

| CB Power mode | Gateway |
|---------------------------------------|-------------|
| On mains | Function ok |
| On battery Power down "Wake Up" | No function |
| | Function ok |

- The MJB – Gateway is not to be used as safety, it is only to be used as a guided system.
- It is important to test the specified notification is working in the correct way, before sending the system to the end user.
- Do not use 2 MJB variants with same device ID on the OpenBus™. This will cause conflicts and the SDT is not able to identify the different products attached.
- Before the final functional test in the production, it is important that the system is re-powered. This is to ensure that all items have been detected on the OpenBus™.
- We recommend the end user to make a regular test procedure, in order to prevent failures and hazardous situations on the system, e.g. squeezed cables. The MJB is not able to detect defective 3rd party products.
- LINAK only takes responsibility for LINAK products, not 3rd. party products.
Please pay attention to the "Patient Environment" Clause 3.79 - EN60601-1 3rd edition: Any volume in which contact can occur between a patient and parts of the medical equipment or between a patient and other persons touching parts of the equipment. Justified practice here is 1.5 m. This volume must be subject to the Risk Analysis.
It is important to inform the customer about this.
- There can be a risk of conflict with other OpenBus™ accessories, such as HB, ACP, etc.
It is therefore recommended to make a system/bit overview.

Cable ordering nos.:

0964140-3000: Gateway cable, 3000 mm, modular plug–open end

0964140-1375: Gateway cable, 1375 mm, modular plug–open end

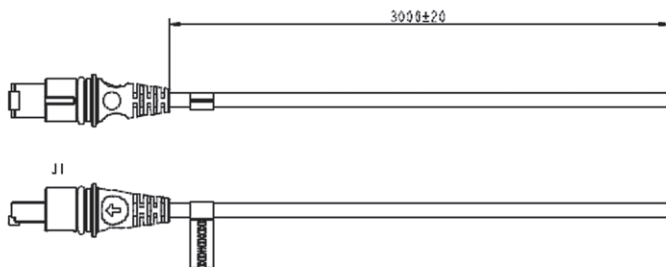

Please note, the slit is placed on the opposite side of the modular plug.

This is to ensure that the cable is only being used for the Gateway MJB.



IP Protection degree:

All LINAK products can be cleaned as follow according to their IP protection, which is stated on the product label.

The IP code specifies the degrees of protection provided by the enclosures. Only the protection against ingress of water (second characteristic numeral) is specified, ingress of solid foreign objects (first characteristic numeral) is not specified and therefore replaced by the letter X in the code.

| IP Protection | Cleaning instructions |
|---------------|--|
| IPX0 | Clean with a damp cloth |
| IPX1 | Clean with a damp cloth |
| IPX2 | Clean with a damp cloth |
| IPX3 | Clean with a damp cloth |
| IPX4 | Clean with a damp cloth |
| IPX5 | Wash with a brush and water, but not water under pressure |
| IPX6 | X Wash with a brush and water. The water can be under pressure, but the system must not be hosed down directly with a high-pressure cleaner. Max. 20°C |
| IPX6 Washable | Clean by the use of water tunnels |

The materials are resistant to the majority of cleaners and disinfectants used in the hospital and nursing home sector.

Cleaning with a steam cleaner, for example, is not permitted, as it will not be possible to maintain a minimum distance of 300 mm from the electrical parts.

The following directions regarding cleaners and disinfectants must be complied with:

- They must not be highly alkaline or acidic (pH value 6-8).
- They must not contain caustic agents.
- Their contents must not be able to change the structure of the surface or adhesion of the plastic.
- They must not break down grease.

The following disinfectants/detergents are recommended:

- Neodischer Dekonta, dosage 1-3%, made by CHEMISCHE FABRIK Dr. WEIGERT,
- CCOTRADE RW, dosage 0.5%, made by CCOTRADE GmbH.

**Warning!**

The systems must not be sprayed directly with a high-pressure cleaner.

**Warning!**

Interconnecting cables must remain plugged in during cleaning to prevent the ingress of water.

**Precaution!**

When cleaned, water must never be sprayed upwards from underneath the bed, because it may enter the cable outlet.

Environmental conditions:

| Environmental conditions | |
|--|---|
| Operating: | |
| Temperature Relative humidity Atmospheric pressure | 5°C to 40°C 20% to 90% @ 30°C – not condensing 700 to 1060 hPa |
| Storage: | |
| Temperature Relative humidity Atmospheric pressure | -10°C to +50°C 20% to 90% @ 30°C – not condensing 700 to 1060 hPa |

Valid where nothing otherwise is stated under the specific products in a later section.

Modular plug with wide alignment groove

To be used with **LINAK products**.
Can be connected to all ports in the MJB, both ports with narrow and wide alignment grooves.

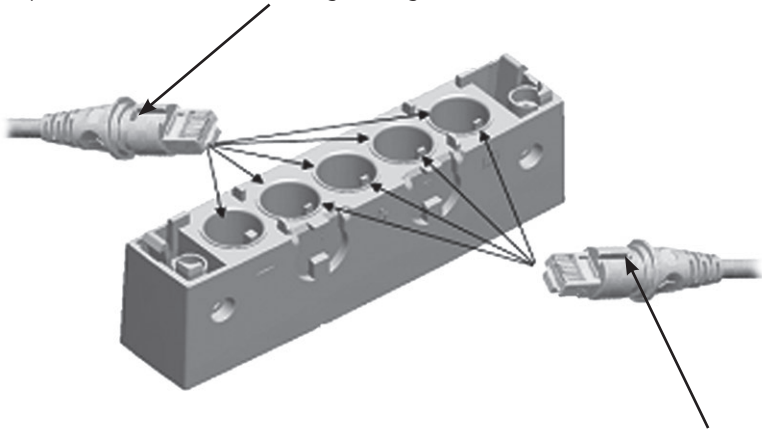





































Modular plug with narrow alignment groove

To be used with **3rd party products**.
Can only be connected to ports in the MJB with narrow slit. This is to prevent 3rd party products to interfere with the OpenBus™ connections.

Key to symbols

The following symbols are used on the label on the LINAK products.

| | | | | | |
|---|---|---|---|---|---|
|  | IEC 60417-5172: Class II equipment |  | UL Listing Mark |  | ZERO standby power |
|  | Product with a thermofuse |  | UL Listing Mark for Canada |  | Regulatory Compliance Mark: The Australian Safety/EMC Regulations |
|  | IEC 60417-5957: For indoor use only |  | UL Listing Mark for Canada and the United States |  | Protection against contact/foreign matter (first character) and water (second character) as per EN60529 |
|  | IEC 60417-5222: Safety isolating transformer, general |  | UL Listing Mark |  | Alternating Current |
|  | IEC 60417-5840: Patient part of type B |  | AS 3108 Australian approval mark |  | Direct current |
|  | Patient part of type BF |  | Various |  | Lock function |
|  | Earth |  | TÜV Rheinland - LGA tested |  | Release function |
|  | IEC 60417-5019: Protective earth; protective ground |  | Recognised Component Mark |  | Charge indicator |
|  | IEC 60417-5002: Positioning of cell |  | Canadian Recognised - Component Mark |  | Safety switch/enable button |
|  | ISO 7000-0434A: Caution, consult accompanying document |  | Recognised Component Mark for Canada and the United States |  | Reduced ETL Recognized Component mark for Canada and United States. |
|  | ISO 7000-1641 Operating instructions |  | PSE-Mark | XXXXXX | X: The mark is always accompanied by a Control Number of 6 or 7 figures. |
|  | Electronics scrap |  | Compliance to all relevant EC directives | | For complete description, see ETL-marking on next page. |
|  | Recycle |  | China Pollution control mark (also indicates recyclability) | | |

ETL-marking

Due to space limitations, the complete ETL-marking demands are not represented on the marking plates.

The full ETL Recognized Component markings are shown here.



C/N 120690
Conforms to ANSI/AAMI Std. E560601-1
Cert. to CSA Std. C22.2 No. 60601-1



C/N 9901916
Conforms to ANSI/AAMI Std. E560601-1
Cert. to CSA Std. C22.2 No. 60601-1



C/N 4008003
Conforms to ANSI/AAMI Std. E560601-1
Cert. to CSA Std. C22.2 No. 60601-1



C/N 4008004
Conforms to ANSI/AAMI Std. E560601-1
Cert. to CSA Std. C22.2 No. 60601-1



C/N 4008005
Conforms to ANSI/AAMI Std. E560601-1
Cert. to CSA Std. C22.2 No. 60601-1



C/N 4008623
Conforms to ANSI/AAMI Std. E560601-1
Cert. to CSA Std. C22.2 No. 60601-1



C/N 4008838
Conforms to ANSI/AAMI Std. E560601-1
Cert. to CSA Std. C22.2 No. 60601-1



C/N 4008671
Conforms to ANSI/AAMI Std. E560601-1
Cert. to CSA Std. C22.2 No. 60601-1



C/N 4009507
Conforms to ANSI/AAMI Std. E560601-1
Cert. to CSA Std. C22.2 No. 60601-1

DRAWING APPENDIX

MJB - Modular Junction Box

MJB

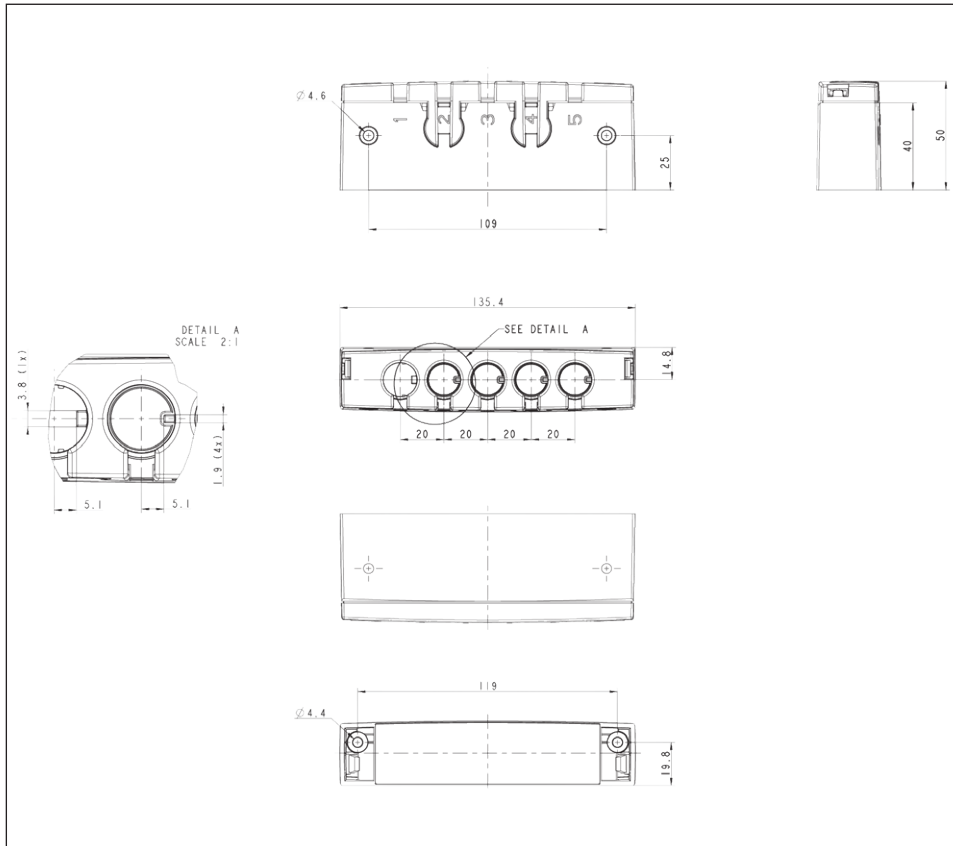

LINAK APPLICATION POLICY

The purpose of the application policy is to define areas of responsibilities in relation to applying a LINAK product defined as hardware, software, technical advice, etc. related to an existing or new customer application.

LINAK products as defined above are applicable for a wide range of applications within the Care and Health, Comfort furniture, Desk and Industry areas. Yet, LINAK cannot know all the conditions under which LINAK products will be installed, used, and operated, as each individual application is unique.

The suitability and functionality of the LINAK product and its performance under varying conditions (application, vibration, load, humidity, temperature, frequency, etc.) can only be verified by testing, and shall ultimately be the responsibility of the LINAK customer using any LINAK product.

It is also the responsibility of the LINAK customer to make and supply a comprehensive user manual of the application.

LINAK shall be responsible solely that the LINAK products comply with the specifications set out by LINAK and it shall be the responsibility of the LINAK customer to ensure that the specific LINAK product can be used for the application in question.

FACTORIES

China

LINAK (Shenzhen) Actuator Systems, Ltd.
Phone: +86 755 8610 6656
Phone: +86 755 8610 6990
E-mail: sales@linak.cn
www.linak.cn

Denmark - Headquarters LINAK A/S - Group Headquarters

Phone: +45 73 15 15 15
Fax: +45 74 45 80 48
Fax (Sales): +45 73 15 16 13
E-mail: info@linak.com
www.linak.com

USA

LINAK U.S. Inc.

North and South American Headquarters
Phone: +1 502 253 5595
Fax: +1 502 253 5596
E-mail: info@linak-us.com
www.linak-us.com

SUBSIDIARIES

Australia

LINAK Australia Pty. Ltd
Phone: +61 3 8796 9777
Fax: +61 3 8796 9778
E-mail: sales@linak.com.au
www.linak.com.au

Austria

LINAK Repräsentanz - Österreich (Wien)
Phone: +43 (1) 890 7446
Fax: +43 (1) 890 744615
E-mail: info@linak.de
www.linak.at

Belgium

LINAK Actuator-Systems NV/SA
(Belgium & Luxembourg)
Phone: +32 (0)9 230 01 09
E-mail: beinfo@linak.be
www.linak.be - www.fr.linak.be

Brazil

LINAK DO BRASIL COMÉRCIO DE
ATUADORES LTDA.
Phone: +55 (11) 2832 - 7070
Fax: +55 (11) 2832 - 7060
E-mail: info@linak.com.br
www.linak.com.br

Canada

LINAK Canada Inc.
Phone: +1 502 253 5595
Fax: +1 416-255-7720
E-mail: info@linak.ca
www.linak-us.com

Czech Republic

LINAK C&S S.R.O.
Phone: +420581741814
Fax: +420581702452
E-mail: info@linak.cz
www.linak.cz

Denmark - International

LINAK International
Phone: +45 73 15 15 15
E-mail: info@linak.com
www.linak.com

Denmark - Sales

LINAK DANMARK A/S
Phone: +45 86 80 36 11
Fax: +45 86 82 90 51
E-mail: linak@linak-silkeborg.dk
www.linak.dk

Finland

LINAK OY
Phone: +358 10 841 8700
E-mail: linak@linak.fi
www.linak.fi

France

LINAK FRANCE E.U.R.L.
Phone: +33 (0) 2 41 36 34 34
Fax: +33 (0) 2 41 36 35 00
E-mail: linak@linak.fr
www.linak.fr

Germany

LINAK GmbH
Phone: +49 6043 9655 0
Fax: +49 6043 9655 60
E-mail: info@linak.de
www.linak.de

India

LINAK A/S India Liaison Office
Phone: +91 120 4531797
Fax: +91 120 4786428
E-mail: info@linak.in
www.linak.in

Ireland

LINAK UK Limited (Ireland)
Phone: +44 (0)121 544 2211
Fax: +44 (0)121 544 2552
+44 (0)796 855 1606 (UK Mobile)
+35 387 634 6554 (Republic Of
Ireland Mobile)

E-mail: sales@linak.co.uk
www.linak.ie

Italy

LINAK ITALIA S.r.l.
Phone: +39 02 48 46 33 66
Fax: +39 02 48 46 82 52
E-mail: info@linak.it
www.linak.it

Japan

LINAK K.K.
Phone: 81-45-533-0802
Fax: 81-45-533-0803
E-mail: linak@linak.jp
www.linak.jp

Malaysia

LINAK Actuators Sdn. Bhd.
Phone: +60 4 210 6500
Fax: +60 4 226 8901
E-mail: info@linak-asia.com
www.linak.my - www.linak.co.id
www.linak.pk - www.linak.ph

Netherlands

LINAK Actuator-Systems B.V.
Phone: +31 76 5 42 44 40 /
+31 76 2 00 11 10
E-mail: info@linak.nl
www.linak.nl

New Zealand

LINAK New Zealand Ltd
Phone: +64 9580 2071
Fax: +64 9580 2072
E-mail: nzsales@linak.com.au
www.linak.com.au

Norway

LINAK Norge AS
Phone: +47 32 82 90 90
E-mail: info@linak.no
www.linak.no

Poland

LINAK Polska
LINAK Danmark A/S (Spółka Akcyjna)
Phone: +48 22 295 09 70 /
+48 22 295 09 71
E-mail: info@linak.pl
www.linak.pl

Republic of Korea

LINAK Korea Ltd.
Phone: +82 2 6231 1515
Fax: +82 2 6231 1516
E-mail: info@linak.kr
www.linak.kr

Russia

LINAK LLC
Phone: +7 495 780 31 61
Fax: +7 495 687 14 26
E-mail: info@linak.ru
www.linak.ru

Spain

LINAK Actuadores, S.L.u
Phone: +34 93 588 27 77
Fax: +34 93 588 27 85
E-mail: esma@linak.es
www.linak.es

Sweden

LINAK Scandinavia AB
Phone: +46 8 732 20 00
Fax: +46 8 732 20 50
E-mail: info@linak.se
www.linak.se

Switzerland

LINAK AG
Phone: +41 43 388 31 88
Fax: +41 43 388 31 87
E-mail: info@linak.ch
www.linak.ch - www.fr.linak.ch
www.it.linak.ch

Taiwan

LINAK (Shenzhen) Actuator systems Ltd.
Taiwan Representative office
Phone: +886 2 27290068
Fax: +886 2 27290096
E-mail: sales@linak.com.tw
www.linak.tw

Turkey

LINAK İth. İhr. San. ve Tic. A.Ş.
Phone: +90 312 4726338
Fax: +90 312 4726635
E-mail: info@linak.com.tr
www.linak.com.tr

United Kingdom

LINAK UK Limited
Phone: +44 (0)121 544 2211
Fax: +44 (0)121 544 2552
E-mail: sales@linak.co.uk
www.linak.co.uk

DISTRIBUTORS

Argentina

NOVOTEC ARGENTINA SRL
Phone: 011-4303-8989 / 8900
Fax: 011-4032-0184
E-mail: info@novotecargentina.com
www.novotecargentina.com

Colombia

MEM Ltda
Phone: +[57] (1) 334-7666
Fax: +[57] (1) 282-1684
E-mail: servicioalcliente@memltda.com.co
www.mem.net.co

India

Mechatronics Control Equipments India Pvt Ltd
Phone: +91-44-28558484, 85
E-mail: bala@mechatronicscontrol.com
www.mechatronicscontrol.com

Indonesia

PT. HIMALAYA EVEREST JAYA
Phone: +6 221 544 8956, +6 221 544 8965
Fax: +6 221 619 1925
Fax (Sales): +6 221 619 4658
E-mail: hejplastic-div@centrin.net.id
www.hej.co.id

Israel

NetivTech LTD
Phone: +972 55-2266-535
Fax: +972 2-9900-560
Email: info@NetivTech.com
www.netivtech.com

Russia

OOD FAM
Phone: +7 812 3319333
Fax: +7 812 3271454
E-mail: purchase@fam-drive.ru
www.fam-drive.ru

Singapore

Servo Dynamics Pte Ltd
Phone: +65 6844 0288
Fax: +65 6844 0070
E-mail: servodynamics@servo.com.sg

South Africa

Industrial Specialised Applications CC
Phone: +27 011 466 0346
E-mail: garth@isagroup.co.za
www.isaza.co.za

United Arab Emirates

Mechatronics
Phone: +971 4 267 4311
Fax: +971 4 267 4312
E-mail: mechtron@emirates.net.ae

Terms of use

The user is responsible for determining the suitability of LINAK products for specific application. LINAK takes great care in providing accurate and up-to-date information on its products.

However, due to continuous development in order to improve its products, LINAK products are subject to frequent modifications and changes without prior notice. Therefore, LINAK cannot guarantee the correct and actual status of said information on its products.

While LINAK uses its best efforts to fulfil orders, LINAK cannot, for the same reasons as mentioned above, guarantee the availability of any other product. Therefore, LINAK reserves the right to discontinue the sale of any product displayed on its website or listed in its catalogues or other written material drawn up by LINAK.

All sales are subject to the Standard Terms of Sale and Delivery for LINAK. For a copy hereof, please contact LINAK.



WE IMPROVE YOUR LIFE