



FPP - Flexible Patient Panel User manual

Contents

Preface	3
Important information	4
Safety instructions	4
Residual risk	5
Before installation, reinstallation or troubleshooting	6
Before start-up	6
During operation	6
Information on the FPP	6
Mounting instructions	7
Flexibility of the arm	8
Repairs	9
Misc. on the FPP system	
Warranty	10
Maintenance	10
IP Protection degree	11
Environmental conditions	12
Keys to symbols	13
Description of the LINAK FPP system	
How to connect the FPP	15
Labels	16
Drawing appendix	17
Addresses	20

Preface

We are delighted that you have chosen a product from LINAK®.

LINAK systems are high-tech products based on many years of experience in the manufacture and development of actuators, electric control boxes, controls and chargers.

This User Manual will tell you how to install, use and maintain your LINAK equipment.

We are sure that your LINAK system will give you many years of problem-free operation. Before our products leave the factory they undergo full function and quality testing. Should you nevertheless experience problems with your systems, you are always welcome to contact your local dealer.

LINAK subsidiaries and some distributors situated all over the world have authorised service centres, which are always ready to help you.

LINAK provides a warranty on all its products. This warranty, however, is subject to correct use in accordance with the specifications, maintenance being done correctly and any repairs being carried out at a service centre, which is authorised to repair LINAK products.

Changes in installation and use of LINAK systems can affect their operation and durability. The products are not to be opened by unauthorised personnel. The User Manual has been written on the basis of our present technical knowledge. We are constantly working on updating the information and we therefore reserve the right to carry out technical modifications.

LINAK A/S

Important information

Description of the various signs used in this manual.

Warning!



Failure to comply with these instructions may result in accidents involving serious personal injury.



Failing to follow these instructions can result in the product being damaged or destroyed.

Safety instructions



Safe use of the system is possible only when the operating instructions are read completely and the instructions contained are strictly observed.

Failure to comply with instructions marked with the "NOTE" symbol may result in serious damage to the system or one of its components.

Persons who do not have the necessary experience or knowledge of the product/ products must not use the product/ products. Besides, persons with reduced physical or mental abilities must not use the product/products, unless they are under surveillance or they have been thoroughly instructed in the use of the apparatus by a person who is responsible for the safety of these persons.

Moreover, children must be under surveillance to ensure that they do not play with the product.



It is important for everyone who is to connect, install, or use the systems to have the necessary information and access to this User Manual.



If there is visible damage to the product it must not be installed.



The appliance is not intended for use by young children or infirm persons without supervision.



Young children should be supervised to ensure that they do not play with the appliance.



Residual risk

Some of the products contains software based components. LINAK has done various possible efforts to assure that the software is free of errors and that the software has been developed according to the rules of IEC 60601-1-4 (software in Medical products). That involves Risk Analysis which shows a small residual risk for unwanted/unintended movement of actuators under specific conditions.

According to the above rules it must be informed and if necessary considered in the Risk analysis of the final application - More details to residual risk can be provided by LINAK if necessary.



Warning!

The plastic parts in the system cannot tolerate cutting oil.



Warning!

LINAK's actuators and electronics are not constructed for use within the following fields:

- Planes and other aircrafts
- Explosive environments
- Nuclear power generation



Warning!

If faults are observed, the products must be replaced.



Warning!

Never spray directly on the products with a high-pressure cleaner.



Warning!

The FPP must be placed readily accessible to the patient. Never let the FPP hang out of the bed.



Warning!

Always insure that the patient is accessible in case of emergency..



Warning!

Never use the FPP as handle.



Warning!

Cables must be secured safely so persons cannot get trapped in it.



The LINAK products cannot tolerate the influence of strong solvents, basic or alkaline liquids.



Do not use sharps devices to activate buttons on the FPP.



Never us the FPP as support device at all. It cannot be used as i.e. table or notepad nor can things be hanged on it.

Before installation, re-installation, or troubleshooting

- Stop the application
- Switch off the power supply and pull out the mains plug.
- Relieve the application of any loads, which may be released during the work.

Before start-up

- Make sure that the system has been installed as instructed in the User Manual.
- Make sure that the voltage of the control box is correct before the system is connected to the mains.
- System connection. The individual parts must be connected before the control box is connected to the mains.

During operation

- Ensure that the cables are not damaged.
- Unplug the mains cable on mobile equipment before it is moved.

Information on the FPP:

FPP (Flexible Patient Panel) is a user-friendly control panel especially for elderly people, placed on a flexible arm, on the bed frame behind the patients head. The FPP makes the patient more independent, is ergonomically designed and easy to install on even the most advanced equipment.

The FPP has a flexible arm which makes it immediately available by simply pulling and bending it into position. When not in use the patient can also push it slightly away. However it is never dropped or lost on the floor.

The FPP is for use with a variety of different bed types and is therefore compatible with control boxes that use an OpenBus™ interface i.e. CB6S, CB16 and CB20.

The FPP controls up to 3 channels (6 buttons). It is ergonomically shaped and easy to operate with one hand. The combination of panel and arm is sufficiently stiff to avoid using both hands. Available with two different types of buttons: Normal touch (Dome) and Soft touch. The Soft touch type is made especially for elderly people.

Approvals:

LINAK and UL International DEMKO A/S are currently in the process of certifying FPP re. UL60601 and EN60601-1.

Mounting instructions:

The FPP is meant for mounting at the head end of a bed so the patient is able to see and operate it with an easy push of a button. After use it can be moved shortly away with an easy movement.

The FPP comes with a cable attached as shown on the illustration. The bottom part of the arm is prepared for mounting inside a bracket - fitting the diameter of the arm.

The bracket is not delivered by LINAK but must be designed and made by the customer. It must fit the dimensions shown. A suggestion to a design is ill. on below pictures as well as the dimensions of the parts for fixation.

Ill. of Dimensions:

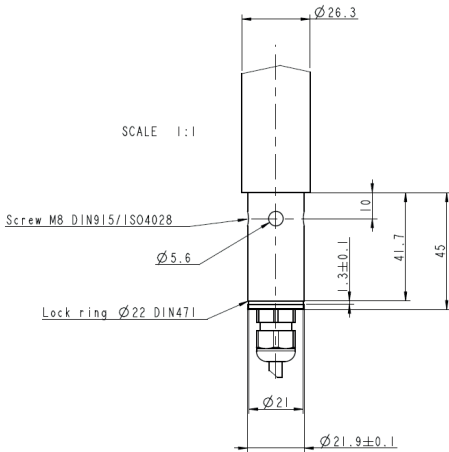

Pointed screw

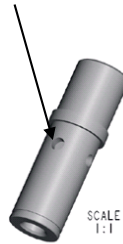

Possible bracket design

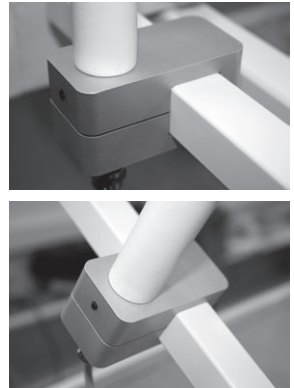

The FPP must be mounted in such a manner that it is secured against rotation.

For this purpose the bracket end of the arm has 4 x drilled holes - one of the 4 holes must be secured via the bracket with a slotted set screw with cone point (pointed screw).

Otherwise it may slide away from the user when operated.

Flexibility of the arm:

As illustrated from the pictures below the panel itself can be moved and angled in a number of positions. The arm as well can be bended to have it closer to or move it away from the user.



The lock function

Between the arm and the panel there is a lock/unlock function. It enables the user to turn the panel into a preferred position.

Locking of the function:

Turn the panel clockwise. The lock must be fully opened to move the panel

Unlocking of the function:

Turn the panel counter clockwise

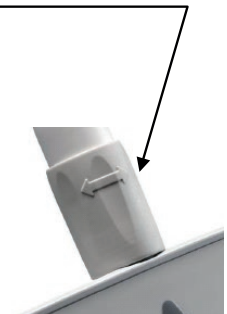

Repairs

In order to avoid the risk of malfunction, all repairs must only be carried out by authorized LINAK workshops or repairers, as special tools must be used and special gaskets must be fitted. Products under warranty must also be returned to authorized LINAK workshops.



Warning!

If any of the LINAK products are opened, there will be a risk of subsequent malfunction.

Disposal of LINAK's products

LINAK's products may be disposed of, possibly by dividing them into different waste groups for recycling or combustion.

We recommend that our product is disassembled as much as possible at the disposal and that you try to recycle it. As an example of main groups within sorting of waste we can mention the following:

Metal, plastic, cable scrap, combustible material and collection for recoverable resources.

Some of these main groups can be sub-divided into groups e.g. metal can be divided into iron, stainless steel and aluminium and alloy steel. Plastic can e.g. be divided into ABS, PA, PE and PP.

The FPP can be disassembled and sorted into the following recycling groups:

Component	Recycling group
FPP	Plastic housing – Plastic recycling or combustion
	Cable – Cable scrap or combustion
	PC-board – Electronics Scrap

By now all our casted plastic units are provided with an interior code for plastic types and fiber contents, if any.

Misc. on the FPP system

Warranty and service life

The LINAK warranty covers manufacturing defects in the products, starting from the date of manufacture. There is 18 months' for MEDLINE and CARELINE products. The warranty is limited to the value of the LINAK product.

LINAK's guarantee is only valid so far as the products have been used and maintained correctly and has not been tampered with. Furthermore, the products must not be exposed to violent treatment. In the event of this, the warranty will be ineffective / invalid. LINAK's warranty is only valid if the system is unopened and has been used correctly.

All LINAK products are designed to have an optimum service life as a matter of course, but the expected service life in a specific application is very dependent on how the products are used.

Maintenance

- The LINAK products must be cleaned at regular intervals to remove dust and dirt and inspected for mechanical damage, wear and breaks.
- The LINAK FPP is a closed unit and requires no internal maintenance.
- IPX6 is waterproof.
- Make sure that the plugs are correctly fitted with O-rings before washing.
- O-rings: When individual parts are replaced in a LINAK IPX6 system, the O-rings on all parts, must be replaced at the same time. On control boxes with a replaceable mains fuse, the O-ring in the fuse cover must be replaced every time the cover has been removed. The O-rings must be greased in water free Vaseline when replacing them. Make sure that the counterpart - the socket - is clean and undamaged.
- Electronics must be inspected at attachment points, wires, cabinet, and plugs.
- Inspect the connections, cables, cabinet, and plugs, and check for correct functioning.

IP Protection degree:

All LINAK products can be cleaned as follow according to their IP protection which is stated on the product label.

The IP code specifies the degrees of protection provided by the enclosures. Only the protection against ingress of water (second characteristic numeral) is specified, ingress of solid foreign objects (first characteristic numeral) is not specified and therefore replaced by the letter X in the code.

IP Protection	Cleaning instructions
IPX0	Clean with a damp cloth.
IPX1	Clean with a damp cloth.
IPX2	Clean with a damp cloth.
IPX3	Clean with a damp cloth.
IPX4	Clean with a damp cloth.
IPX5	Wash with a brush and water, but not water under pressure
IPX6	X Wash with a brush and water. The water can be under pressure, but the system must not be hosed down directly with a high pressure cleaner. Max. 20°C
IPX6 Washable	Clean by the use of water tunnels

The materials are resistant to the majority of cleaners and disinfectants used in the hospital and nursing home sector.

Cleaning with a steam cleaner, for example, is not permitted, as it will not be possible to maintain a minimum distance of 300 mm from the electrical parts.

The following directions regarding cleaners and disinfectants must be complied with:

- They must not be highly alkaline or acidic (pH value 6-8).
- They must not contain caustic agents.
- Their contents must not be able to change the structure of the surface or adhesion of the plastic.
- They must not break down grease.

Practical information:

The folie is glued together with the housing of the FPP

The following disinfectants/detergents are recommended:

- Neodischer Dekonta, dosage 1-3%, made by CHEMISCHE FABRIK Dr. WEIGERT
- CCOTRADE RW, dosage 0.5%, made by CCOTRADE GmbH.

**Warning!**

The systems must not be sprayed directly with a high-pressure cleaner.

**Warning!**

Interconnecting cables must remain plugged in during cleaning to prevent the ingress of water.

**Precaution!**

When cleaned water must never be sprayed upwards from underneath the bed, cause is may enter the cable outlet.















Environmental conditions:

Environment conditions	
Operating:	
Temperature	5°C to 40°C
Relative humidity	20% to 90% @ 30°C – not condensing
Atmospheric pressure	700 to 1060 hPa
Storage:	
Temperature	-10°C to +50°C
Relative humidity	20% to 90% @ 30°C – not condensing
Atmospheric pressure	700 to 1060 hPa

Valid where nothing otherwise is stated under the specific products in a later section.

Key to symbols

The following symbols are used on the label on the LINAK products.

	Type B equipment, as per EN 60601-1		Lock function
	Protection against contact/foreign matter (first character) and water (second character) as per EN60529		Release function
	Class 2 equipment		Charge indicator
	For indoor use		Safety switch/enable button
	Double insulated transformer		
	Protective earth		
	Alternating Current		
	Direct current		
	Attention, consult accompanying documents		



Demko approval



Fimko approval



APPROVAL
V94265

Australian approval mark

APPROVAL
NO.:97122

Australian approval mark



Recognised - Component Mark



Canadian
Recognised - Component Mark



Recognised
Component Mark for Canada and
the United States



T-Mark



RW-Tuv approval



Tuv.Produkt Service



TÜVRheinland



ETL



C-ETL

CS95145V



LGA



UL Listing Mark



C-UL Listing Mark



C-UL US Listing Mark



UL Listing Mark

File E97199

UL file number

File E175209

UL file number

File E151104

UL file number



CSA



PSE-Mark



Product with a thermofuse



For indoor use (House).



Safety isolating transformer.



Electronics scrap



Equipment Kl.2 (Double square)



Patient part of type B (Mand)



Patient part of type BF



Earth protection

KL.1

Equipment class 1.



Earth



CE Mark



C-TICK

Description of the LINAK FPP system:

How to connect the FPP:

OpenBus™ CB (CB6S)

FPP

Handset

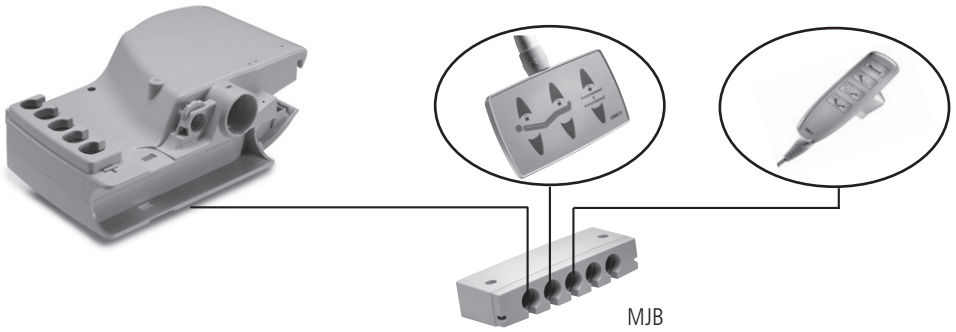

Alternatively:

OpenBus™ CB (CB16)

FPP

Handset

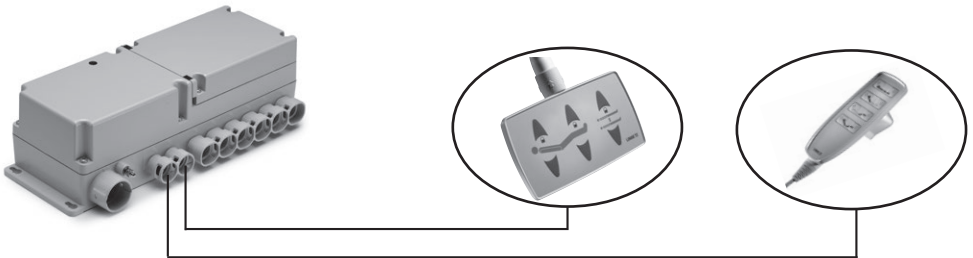

Label for FPP600101+12000

LINAK[®] 

WE IMPROVE YOUR LIFE

Item : FPP600101 + 12000

Date : 2009.09.28 IPX6 S.O.7654321

NOT TO BE OPENED BY UNAUTHORIZED PERSONNEL

MADE BY LINAK A/S DENMARK



P.O.1234567 - 0001





N576

Label for FPP600201+02000

LINAK[®] 

WE IMPROVE YOUR LIFE

Item : FPP600201 + 02000

Date : 2009.09.28 IPX6 S.O.7654321

NOT TO BE OPENED BY UNAUTHORIZED PERSONNEL

MADE BY LINAK A/S DENMARK



P.O.1234567 - 0001







N576

DRAWING APPENDIX

FPP - Flexible Patient Panel

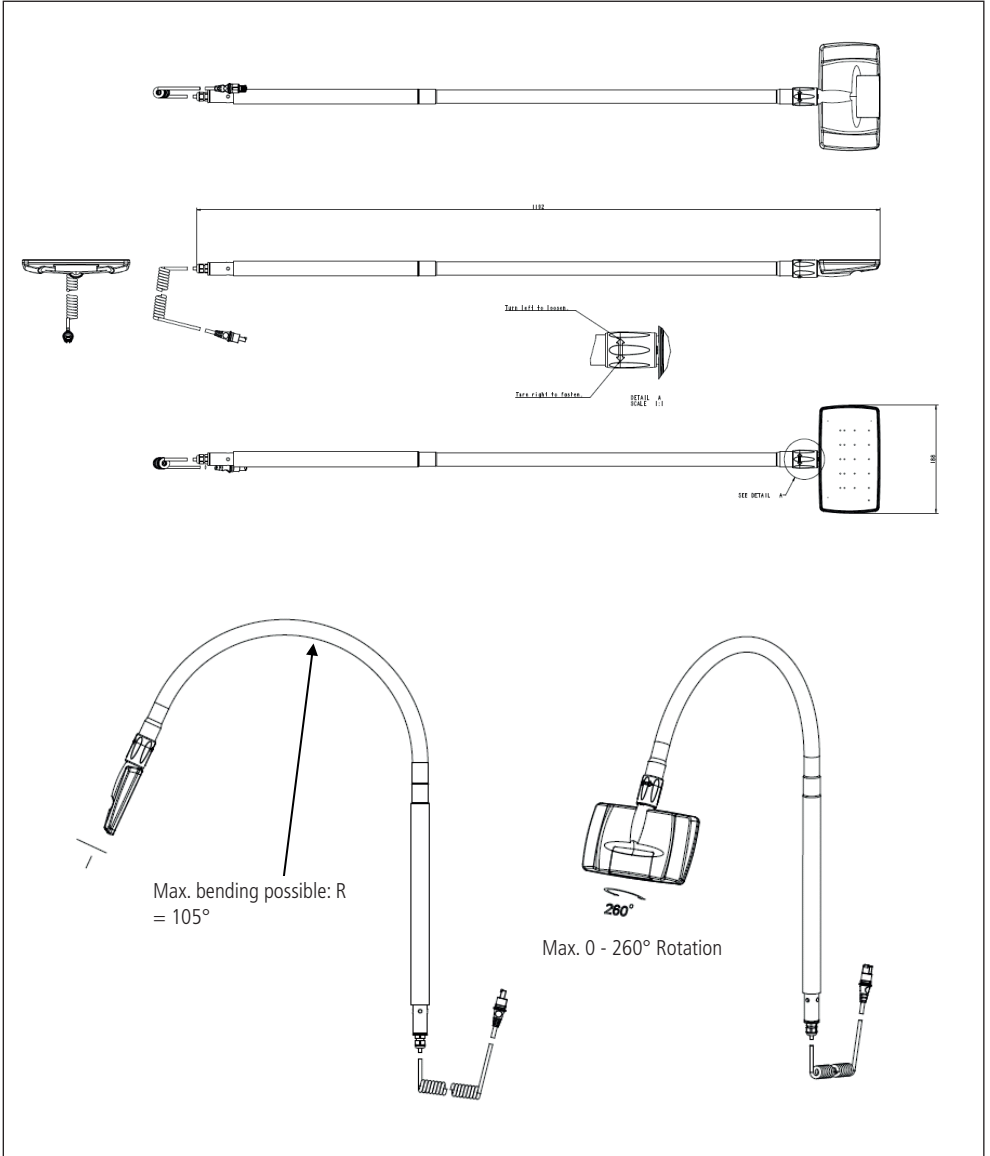
FPP



LINAK APPLICATION POLICY

The purpose of the application policy is to define areas of responsibilities in relation to applying a LINAK product defined as hardware, software, technical advice, etc. related to an existing or new customer application.

LINAK products as defined above are applicable for a wide range of applications within the Care and Health, Comfort furniture, Desk and Industry areas. Yet, LINAK cannot know all the conditions under which LINAK products will be installed, used, and operated, as each individual application is unique.

The suitability and functionality of the LINAK product and its performance under varying conditions (application, vibration, load, humidity, temperature, frequency, etc.) can only be verified by testing, and shall ultimately be the responsibility of the LINAK customer using any LINAK product.

It is also the responsibility of the LINAK customer to make and supply a comprehensive user manual of the application.

LINAK shall be responsible solely that the LINAK products comply with the specifications set out by LINAK and it shall be the responsibility of the LINAK customer to ensure that the specific LINAK product can be used for the application in question.

FACTORIES

China

LINAK (Shenzhen) Actuator Systems, Ltd.
Phone: +86 755 8610 6656
Phone: +86 755 8610 6990
E-mail: sales@linak.cn
www.linak.cn

Denmark - Headquarters

LINAK A/S - Group Headquarters

Phone: +45 73 15 15 15
Fax: +45 74 45 80 48
Fax (Sales): +45 73 15 16 13
E-mail: info@linak.com
www.linak.com

USA

LINAK U.S. Inc.

North and South American Headquarters
Phone: +1 502 253 5595
Fax: +1 502 253 5596
E-mail: info@linak-us.com
www.linak-us.com

SUBSIDIARIES

Australia

LINAK Australia Pty. Ltd
Phone: +61 3 8796 9777
Fax: +61 3 8796 9778
E-mail: sales@linak.com.au
www.linak.com.au

Austria

LINAK Repräsentanz - Österreich (Wien)
Phone: +43 (1) 890 7446
Fax: +43 (1) 890 744615
E-mail: info@linak.de
www.linak.at

Belgium

LINAK Actuator-Systems NV/SA
(Belgium & Luxembourg)
Phone: +32 (0)9 230 101 09
Fax: +32 (0)9 230 88 80
E-mail: beinfo@linak.be
www.linak.be - www.fr.linak.be

Brazil

LINAK DO BRASIL COMÉRCIO DE
ATUADORES LTDA.
Phone: +55 (11) 2832 - 7070
Fax: +55 (11) 2832 - 7060
E-mail: info@linak.com.br
www.linak.com.br

Canada

LINAK Canada Inc.
Phone: +1 502 253 5595
Fax: +1 416-255-7720
E-mail: info@linak.ca
www.linak-us.com

Czech Republic

LINAK C&S S.R.O.
Phone: +420581741814
Fax: +420581702452
E-mail: info@linak.cz
www.linak.cz

Terms of use

The user is responsible for determining the suitability of LINAK products for specific application. LINAK takes great care in providing accurate and up-to-date information on its products. However, due to continuous development in order to improve its products, LINAK products are subject to frequent modifications and changes without prior notice. Therefore, LINAK cannot guarantee the correct and actual status of said information on its products. While LINAK uses its best efforts to fulfil orders, LINAK cannot, for the same reasons as mentioned above, guarantee the availability of any particular product. Therefore, LINAK reserves the right to discontinue the sale of any product displayed on its website or listed in its catalogues or other written material drawn up by LINAK. All sales are subject to the Standard Terms of Sale and Delivery for LINAK. For a copy hereof, please contact LINAK.

Denmark - International

LINAK International
Phone: +45 73 15 15 15
E-mail: info@linak.com
www.linak.com

Denmark - Sales

LINAK DANMARK A/S
Phone: +45 86 80 36 11
Fax: +45 86 82 90 51
E-mail: linak@linak-silkeborg.dk
www.linak.dk

Finland

LINAK OY
Phone: +358 10 841 8700
E-mail: linak@linak.fi
www.linak.fi

France

LINAK FRANCE E.U.R.L
Phone: +33 (0) 2 41 36 34 34
Fax: +33 (0) 2 41 36 35 00
E-mail: linak@linak.fr
www.linak.fr

Germany

LINAK GmbH
Phone: +49 6043 9655 0
Fax: +49 6043 9655 60
E-mail: info@linak.de
www.linak.de

India

LINAK A/S India Liaison Office
Phone: +91 120 4531797
Fax: +91 120 4786428
E-mail: info@linak.in
www.linak.in

Ireland

LINAK UK Limited (Ireland)
Phone: +44 (0)121 544 2211
Fax: +44 (0)121 544 2552
+44 (0)796 855 1606 (UK Mobile)
+35 387 634 6554 (Republic Of
Ireland Mobile)

E-mail: sales@linak.co.uk
www.linak.ie

Italy

LINAK ITALIA S.r.l.
Phone: +39 02 48 46 33 66
Fax: +39 02 48 46 82 52
E-mail: info@linak.it
www.linak.it

Japan

LINAK K.K.
Phone: 81-45-533-0802
Fax: 81-45-533-0803
E-mail: linak@linak.jp
www.linak.jp

Malaysia

LINAK Actuators Sdn. Bhd.
Phone: +60 4 210 6500
Fax: +60 4 226 8901
E-mail: info@linak-asia.com
www.linak.my - www.linak.co.id
www.linak.pk - www.linak.ph

Netherlands

LINAK Actuator-Systems B.V.
Phone: +31 76 5 42 44 40 /
+31 76 2 00 11 10
E-mail: info@linak.nl
www.linak.nl

New Zealand

LINAK New Zealand Ltd
Phone: +64 9580 2071
Fax: +64 9580 2072
E-mail: nzsales@linak.com.au
www.linak.com.au

Norway

LINAK Norge AS
Phone: +47 32 82 90 90
E-mail: info@linak.no
www.linak.no

Poland

LINAK Polska
LINAK Danmark A/S (Spółka Akcyjna)
Phone: +48 22 295 09 70 /
+48 22 295 09 71
E-mail: info@linak.pl
www.linak.pl

Republic of Korea

LINAK Korea Ltd.
Phone: +82 2 6231 1515
Fax: +82 2 6231 1516
E-mail: info@linak.kr
www.linak.kr

Russia

LINAK LLC
Phone: +7 495 780 31 61
Fax: +7 495 687 14 26
E-mail: info@linak.ru
www.linak.ru

Spain

LINAK Actuadores, S.L.U
Phone: +34 93 588 27 77
Fax: +34 93 588 27 85
E-mail: esma@linak.es
www.linak.es

Sweden

LINAK Scandinavia AB
Phone: +46 8 732 20 00
Fax: +46 8 732 20 50
E-mail: info@linak.se
www.linak.se

Switzerland

LINAK AG
Phone: +41 43 388 31 88
Fax: +41 43 388 31 87
E-mail: info@linak.ch
www.linak.ch - www.fr.linak.ch
www.it.linak.ch

Taiwan

LINAK (Shenzhen) Actuator systems Ltd.
Taiwan Representative office
Phone: +886 2 27290068
Fax: +886 2 27290096
E-mail: sales@linak.com.tw
www.linak.tw

Turkey

LINAK İth. İhr. San. ve Tic. A.Ş.
Phone: +90 312 4726338
Fax: +90 312 4726635
E-mail: info@linak.com.tr
www.linak.com.tr

United Kingdom

LINAK UK Limited
Phone: +44 (0)121 544 2211
Fax: +44 (0)121 544 2552
E-mail: sales@linak.co.uk
www.linak.co.uk

DISTRIBUTORS

Argentina

NOVOTEC ARGENTINA SRL
Phone: 011-4303-8989 / 8900
Fax: 011-4032-0184
E-mail: info@novotecargentina.com
www.novotecargentina.com

Colombia

MEM Ltda
Phone: +[57] (1) 334-7666
Fax: +[57] (1) 282-1684
E-mail: servicioalcliente@memltda.com.co
www.mem.net.co

India

Mechatronics Control Equipments India Pvt Ltd
Phone: +91-44-28558484, 85
E-mail: bala@mechatronicscontrol.com
www.mechatronicscontrol.com

Indonesia

PT. HIMALAYA EVEREST JAYA
Phone: +6 221 544 8956, +6 221 544 8965
Fax: +6 221 619 1925
Fax (Sales): +6 221 619 4658
E-mail: hejplastic-div@centrin.net.id
www.hej.co.id

Israel

NetivTech LTD
Phone: +972 55-2266-535
Fax: +972 2-9900-560
Email: info@NetivTech.com
www.netivtech.com

Russia

OOD FAM
Phone: +7 812 3319333
Fax: +7 812 3271454
E-mail: purchase@fam-drive.ru
www.fam-drive.ru

Singapore

Servo Dynamics Pte Ltd
Phone: +65 6844 0288
Fax: +65 6844 0070
E-mail: servodynamics@servo.com.sg

South Africa

Industrial Specialised Applications CC
Phone: +27 011 466 0346
E-mail: garth@isagroup.co.za
www.isaza.co.za

United Arab Emirates

Mechatronics
Phone: +971 4 267 4311
Fax: +971 4 267 4312
E-mail: mechtron@emirates.net.ae



WE IMPROVE YOUR LIFE