

With 3 mm endplates

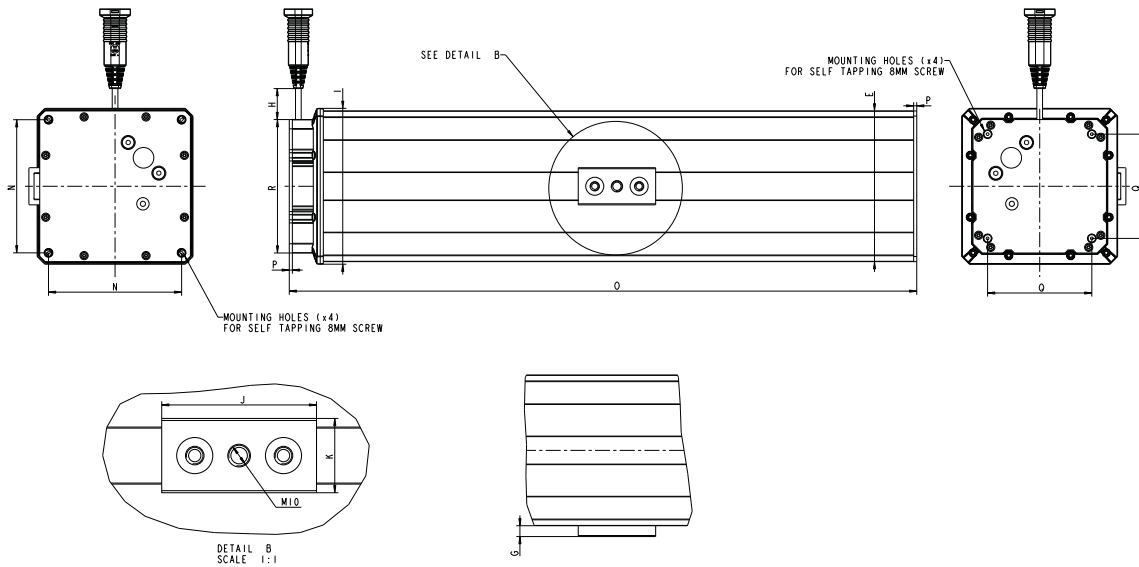

With 10 mm endplates

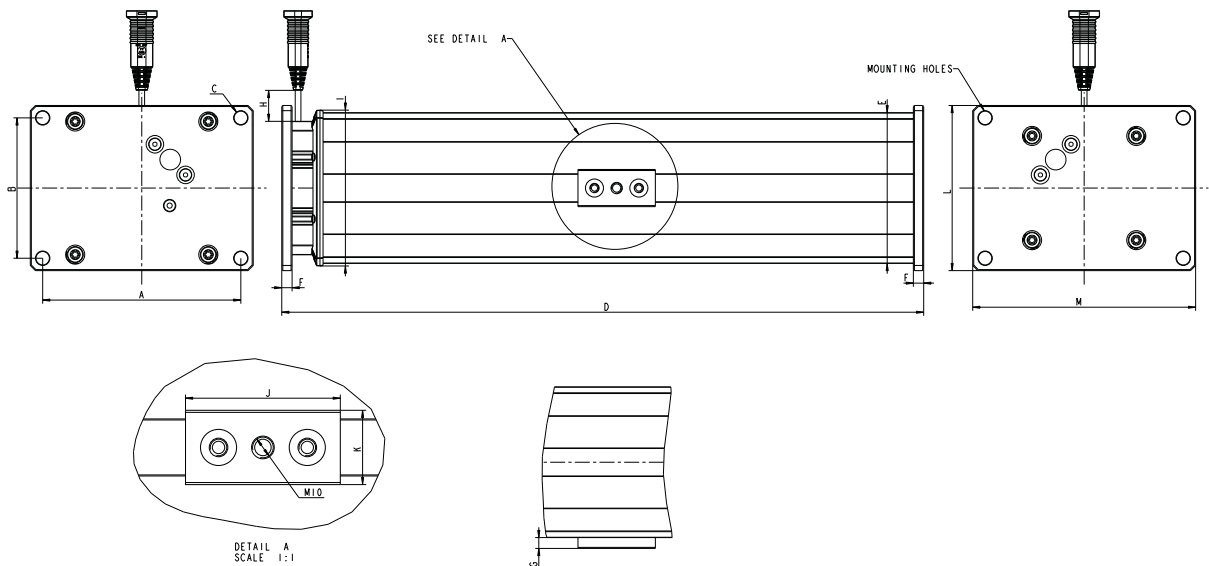

	in	mm		in	mm
A	7.56 ± 0.02	192 ± 0.5	L	6.30 ± 0.20	160 ± 0.5
B	5.35 ± 0.02	136 ± 0.5	M	8.50 ± 0.20	216 ± 0.5
C	∅0.51	∅13	N	5.08 ± 0.01	129 ± 0.3
D	Stroke + 7.95 ± 0.2	Stroke + 202 ± 4	O	Stroke + 7.40 ± 0.2	Stroke + 188 ± 4
E	5.748 SQ.	146 SQ.	P	0.12	3
F	0.39	10	Q	3.98 ± 0.01	101 ± 0.3
G	0.41	10.5	R	4.92 SQ.	125 SQ.
H	88.58 ± 0.20	2250 ± 50	S	4.72 SQ.	120 SQ.
I	5.94 SQ.	151 SQ.	T	4.07 SQ.	103.3 SQ.
J	3.95	75	U	3.26 ± 0.01	82.92 ± 0.3
K	1.42	36	V	4.04 ± 0.01	102.62 ± 0.3

All rights reserved

Date:

17 June 2010

Description:

Lifting Column LC25



WE IMPROVE YOUR LIFE