

IC Control

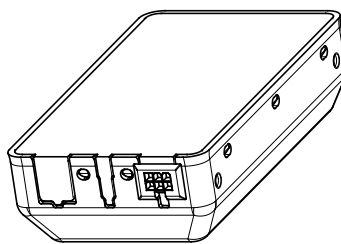

IC Companion

Combination code	Type
DL5xxxxxMxxxxxx	IC Control
DL5xxxxxSxxxxxx	IC Companion

Socket combination

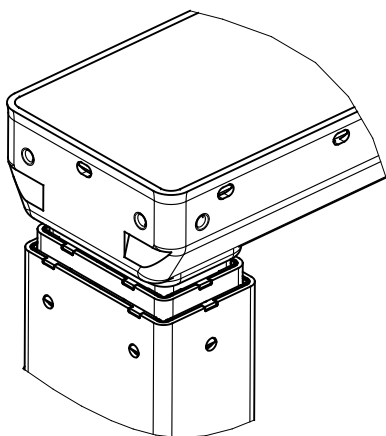

Standard

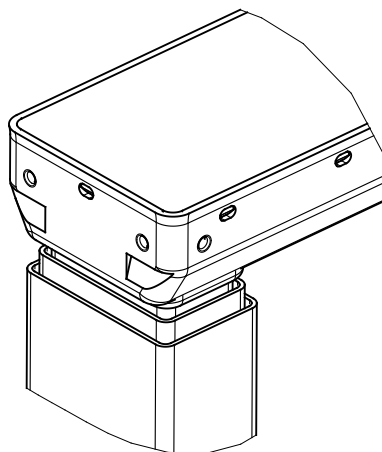

PLUS™

Profile design

All rights reserved

Date:

30 June 2023

Description:

DL6 IC - Sockets and design



WE IMPROVE YOUR LIFE