



## Desk Panel with display - DP1CS Data sheet

# DP1CS

---

The DP1CS desk panel is a perfect choice for a wide range of desks and workstations with a demand for a panel with height read-out. The up and down buttons have been made extra "user-friendly" as they are shaped "according to the function" meaning the user can feel the differences and it is not necessary to look when operating the system. The DP1CS has a display for height read-out in either cm or inches. The display switches off when not in use thereby saving power in standby mode. As an extra feature, the panel can be used for diagnostics as error codes can be displayed.



---

## Features:

- Up and down drive
- 3 memory positions
- Display with white LED
- Colour black, RAL 9005
- Welded plastic housing with mounting holes (LINAK does not deliver the screws)
- Same PCB and software as used in DPF1C and DPF4T
- Same configuration as DPF1C
- Black cable: 1700 mm (+/-70 mm) straight cable with modular jack
- PVC free





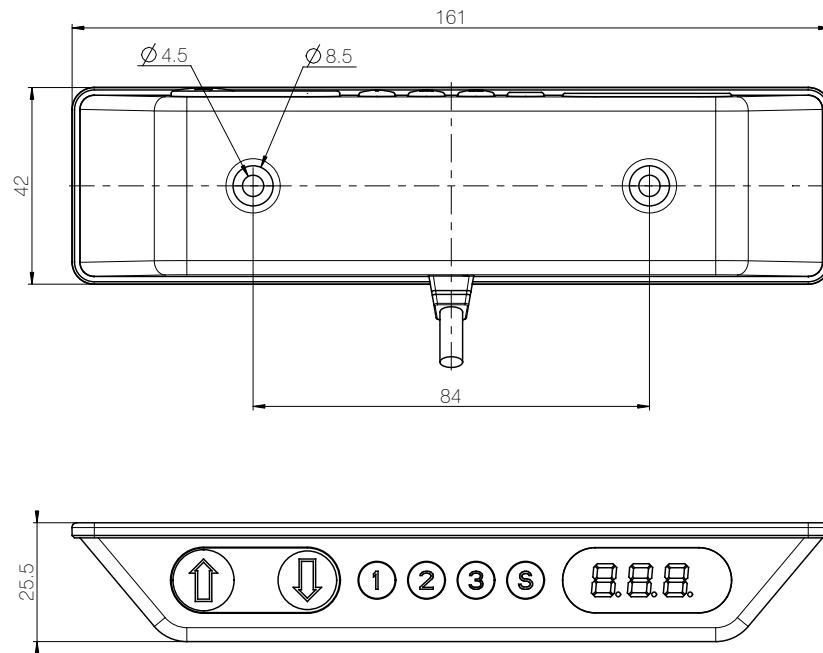

## Usage:

- Ambient temperature +5° to + 40°C
- Compatible with all DESKLINE control boxes
- Approved according to EN 60335-1 and UL962

## Dimensions



## Functions:

-  Desk up
-  Desk down
-  Memory 1
-  Memory 2
-  Memory 3
-  Store memory



## DP1CS

### Ordering example:

<p>DP 1 C S00 - 10 0 0 0 6</p>	<p><b>Cable:</b> 6 = 1700 mm (+/-70 mm) straight cable with modular jack</p> <p><b>Display colour:</b> 0 = White display (Standard)</p> <p><b>Housing colour:</b> 0 = Black</p> <p><b>Height unit:</b> 0 = inch displayed 1 = cm</p> <p><b>Standard:</b> 10 = Standard</p> <p><b>Standard:</b> S00 = Standard</p> <p><b>Type:</b> C = Up/down with display and memory</p> <p><b>Number of channels:</b> 1 = One reference</p>
--------------------------------	---

---

**Terms of use**

The user is responsible for determining the suitability of LINAK products for specific application. LINAK takes great care in providing accurate and up-to-date information on its products.

However, due to continuous development in order to improve its products, LINAK products are subject to frequent modifications and changes without prior notice. Therefore, LINAK cannot guarantee the correct and actual status of said information on its products.

While LINAK uses its best efforts to fulfill orders, LINAK cannot, for the same reasons as mentioned above, guarantee the availability of any particular product. Therefore, LINAK reserves the right to discontinue the sale of any product displayed on its website or listed in its catalogues or other written material drawn up by LINAK.

All sales are subject to the Standard Terms of Sale and Delivery for LINAK. For a copy hereof, please contact LINAK.