

# UBL4 Motion Data Sheet

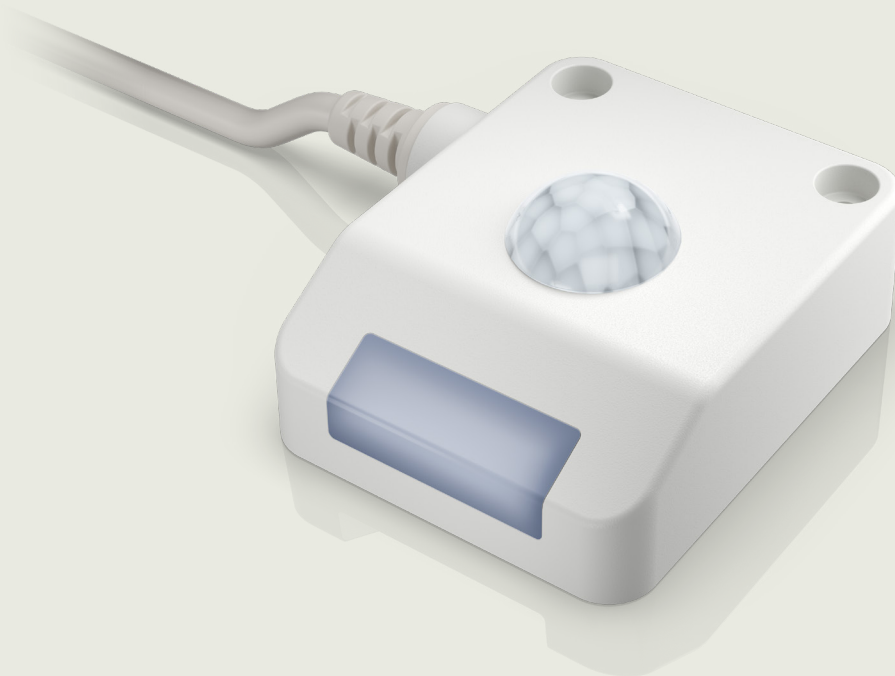

---

## Contents

<b>Introduction.....</b>	<b>3</b>
<b>Features and options .....</b>	<b>3</b>
<b>Usage .....</b>	<b>4</b>
<b>Functionality.....</b>	<b>5</b>
<b>Ordering example .....</b>	<b>7</b>
<b>Dimensions .....</b>	<b>8</b>

## Introduction

The Under Bed Light, UBL4 Motion, consists of a bed light with a sensor that activates when motion is detected. It is intended for use within primarily nursing homes and homecare and works with LINAK® OpenBus™ systems.

The guiding light automatically turns on when the patient leaves the bed and therefore helps prevent fall accidents in poorly lit rooms. The automatic light eases patient orientation and offers more comfort.

The UBL4 Motion offers the following advantages:

- Integrated Passive Infra-Red (PIR) sensor for automatic LED light by motion detection
- The UBL4 Motion is intelligent and will only activate when light is needed, i.e. in poorly lit rooms
- LED light dims after 10 seconds of inactivity.
- IPX4
- Easy installation on new and existing systems

## Features and options

Number of LEDs:	6 LEDs
Light intensity:	<b>Two fixed light intensities:</b> <b>Maximum:</b> 310 lux at 100% <b>Dimmed:</b> 141 lux at 44% (see functionality section)
PIR sensor:	110 degrees at a distance of 2 meters
Photodiode:	Daylight level sensitivity detector. Active when room light level is below 35 lux. Inactive when room light level is above 75 lux.
Current consumption:	Vbus: 8 V < 1 mA Vperm: 40 V < 23 mA
Interface:	RJ45 modular plug
Colour:	Light grey, RAL 7035
Protection class:	IPX4
Cable lengths:	3 fixed: 500 mm, 1250 mm, 2500 mm
Cable type:	PVC
Flammability rating:	V0

## Usage

Operation temperature:	+5 °C to +40 °C
Storage temperature:	-10 °C to +50 °C
Relative humidity:	20% to 80% – non-condensing
Atmospheric pressure:	700 to 1060 hPa
Meters above sea level:	Max. 3000 meters
Compatibility:	LINAK OpenBus™ control boxes
Approvals:	IEC 60601-1 ANSI/AAMI ES60601-1 CSA CAN/CSA-C22.2 NO. 60601-1

## Functionality

The UBL4 Motion is equipped with an integrated PIR sensor for automatic light by motion detection. The UBL4 Motion also has a photodiode for daylight detection. The UBL4 Motion only turns on when the room is dark (room lux level below 35).

### Functionality visualisation

1. Patient is in bed

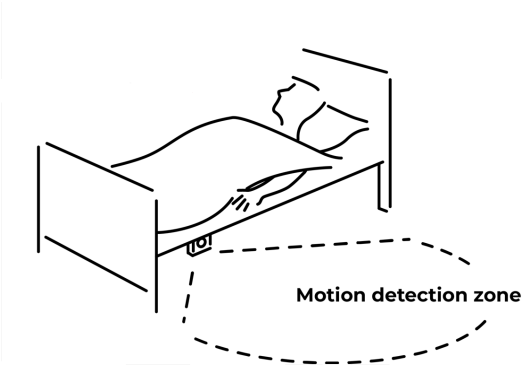

2. Patient is sitting up, thus activating the bed sensor

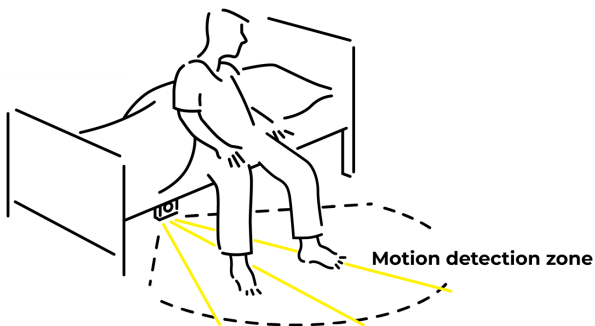

3. Patient walks away from the bed and exits the motion detection zone. After 10 seconds of inactivity, the guiding light dims.

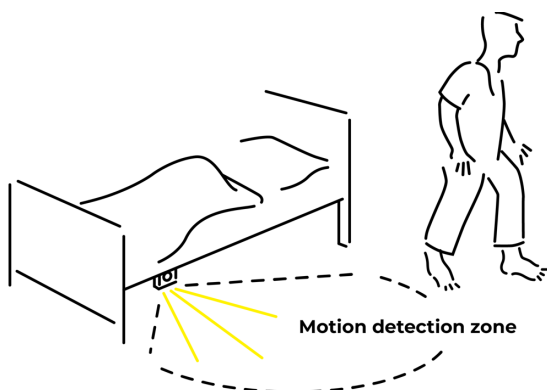

4. Patient returns to the bed, activates the bed sensor and guiding light is back on max intensity. When the patient enters the bed again, the guiding light will dim after 10 seconds and turn off after 10 minutes.

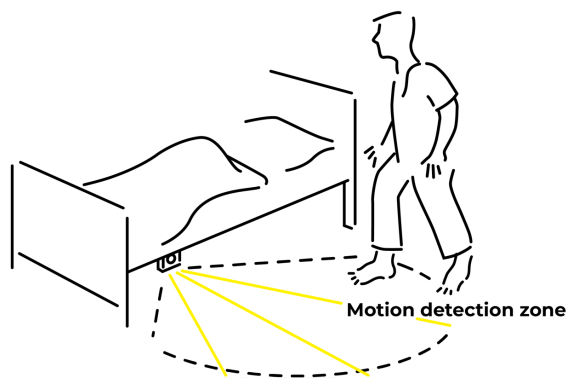

5. The sensor field of vision is obstructed, in this case by the bed sheets, and will not function.

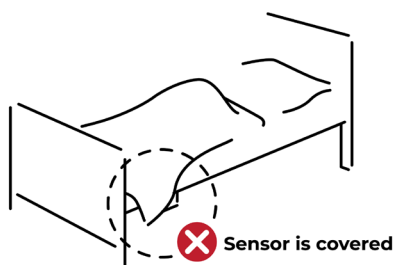

6. The guiding light will only turn on in poorly lit rooms. (Guiding light will turn on when night threshold is below approximately 35 lux. The guiding light will not turn on when light is above approximately 75 lux.)

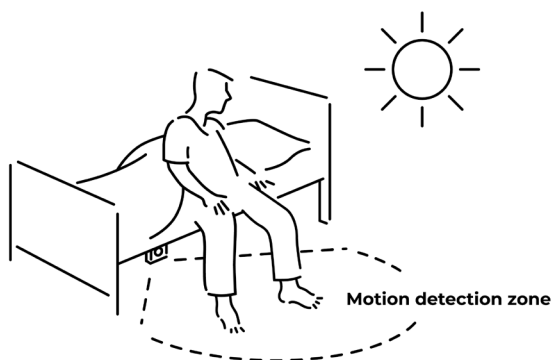

## Ordering example

UBL		
Version	<input type="text" value="4M"/>	4M = Version
Not used	<input type="text" value="0"/>	0 = None
Functionality	<input type="text" value="XX"/>	01 = UBL
Motion sensor	<input type="text" value="XX"/>	01 = Motion sensor
Light sensor mode	<input type="text" value="XX"/>	01 = Light sensor
Standard	<input type="text" value="XX"/>	00 = Standard
IP-degree	<input type="text" value="4"/>	4 = IPX4
		-
Colour	<input type="text" value="2"/>	2 = Grey (RAL7035)
Mounting	<input type="text" value="0"/>	0 = Screw
Cable type	<input type="text" value="1"/>	1 = Modular type PVC
Cable length	<input type="text" value="X"/>	1 = Cable length 500mm 2 = Cable length 1250mm 3 = Cable length 2500mm
Not used	<input type="text" value="0"/>	0 = None
Not used	<input type="text" value="0"/>	0 = None
Not used	<input type="text" value="0"/>	0 = None

Chosen item number: UBL4M0XXXXXXXXX4-201X000

## Dimensions

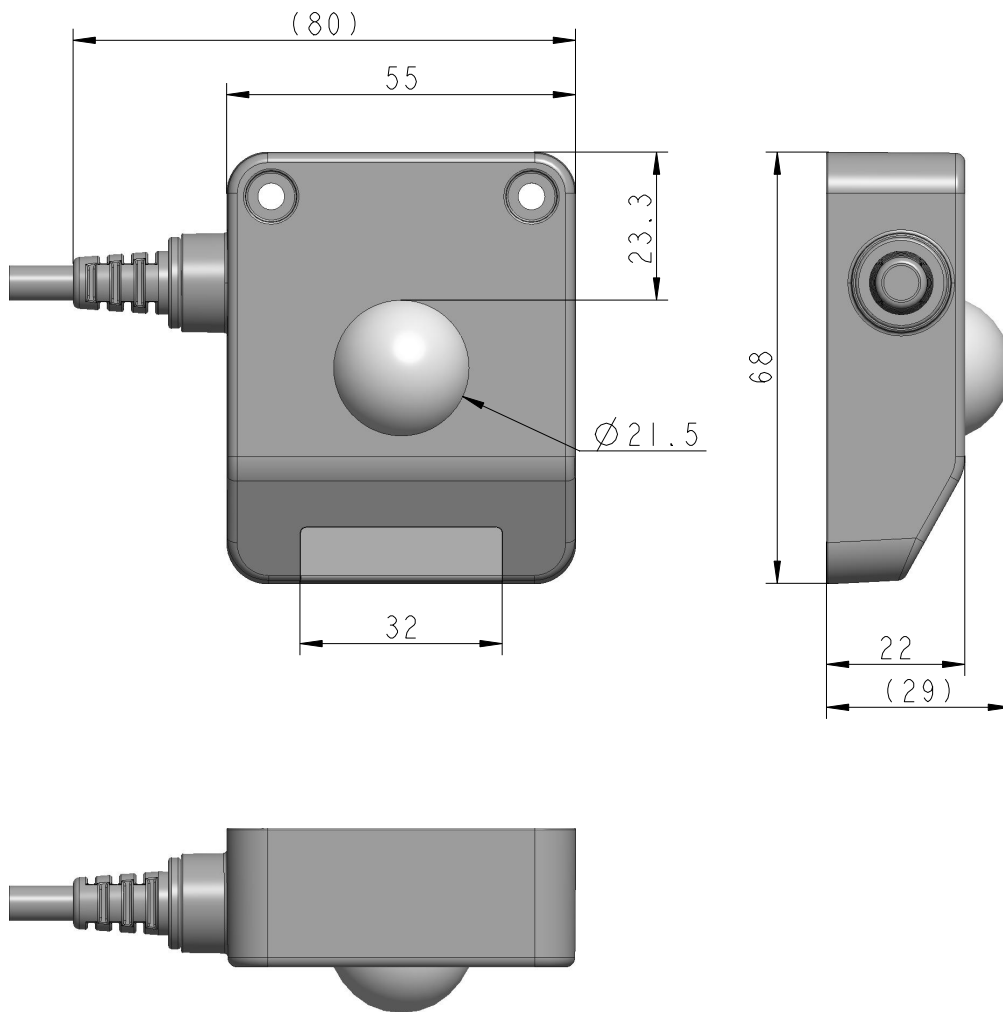

Drawing number: 1078W4001



# Contacts

## FACTORIES

Denmark - Headquarters  
 LINAK A/S  
 Phone: +45 73 15 15 15  
 Fax: +45 74 45 80 48  
 Fax (Sales): +45 73 15 16 13  
 Web: www.linak.com

China  
 LINAK (Shenzhen) Actuator Systems, Ltd.  
 Phone: +86 755 8610 6656  
 Phone: +86 755 8610 6990  
 Web: www.linak.cn

Slovakia  
 LINAK Slovakia s.r.o.  
 Phone: +421 51 7563 444  
 Web: www.linak.sk

Thailand  
 LINAK APAC Ltd.  
 Phone: +66 33 265 400  
 Web: www.linak.com

USA  
 LINAK U.S. Inc.  
 Americas Headquarters  
 Phone: +1 502 253 5595  
 Fax: +1 502 253 5596  
 Web: www.linak-us.com  
 www.linak-latinamerica.com

## SUBSIDIARIES

Australia  
 LINAK Australia Pty. Ltd  
 Phone: +61 3 8796 9777  
 Fax: +61 3 8796 9778  
 E-mail: sales@linak.com.au  
 Web: www.linak.com.au

Austria  
 LINAK Zweigniederlassung - Österreich (Wien)  
 Phone: +43 (1) 890 7446  
 Fax: +43 (1) 890 744615  
 E-mail: info@linak.de  
 Web: www.linak.at - www.linak.hu

Belgium  
 LINAK Actuator-Systems NV/SA  
 (Belgium & Luxembourg)  
 Phone: +32 (0)9 230 01 09  
 E-mail: beinfo@linak.be  
 Web: www.linak.be - www.fr.linak.be

Brazil  
 LINAK Do Brasil Comércio De Atuadores Ltda.  
 Phone: +55 (11) 2832 7070  
 Fax: +55 (11) 2832 7060  
 E-mail: info@linak.com.br  
 Web: www.linak.com.br

Canada  
 LINAK Canada Inc.  
 Phone: +1 502 253 5595  
 Fax: +1 416 255 7720  
 E-mail: info@linak.ca  
 Web: www.linak-us.com

Czech Republic  
 LINAK C&S s.r.o.  
 Phone: +42 058 174 1814  
 Fax: +42 058 170 2452  
 E-mail: info@linak.cz  
 Web: www.linak.cz - www.linak.sk

Denmark - International  
 LINAK International  
 Phone: +45 73 15 15 15  
 E-mail: info@linak.com  
 Web: www.linak.com

Denmark - Sales  
 LINAK Danmark A/S  
 Phone: +45 86 80 36 11  
 Fax: +45 86 82 90 51  
 E-mail: linak@linak-silkeborg.dk  
 Web: www.linak.dk

Finland  
 LINAK OY  
 Phone: +358 10 841 8700  
 E-mail: linak@linak.fi  
 Web: www.linak.fi

France  
 LINAK France E.U.R.L.  
 Phone: +33 (0) 2 41 36 34 34  
 Fax: +33 (0) 2 41 36 35 00  
 E-mail: linak@linak.fr  
 Web: www.linak.fr

Germany  
 LINAK GmbH  
 Phone: +49 6043 9655 0  
 Fax: +49 6043 9655 60  
 E-mail: info@linak.de  
 Web: www.linak.de

India  
 LINAK A/S India Liaison Office  
 Phone: +91 120 4531797  
 Fax: +91 120 4786428  
 E-mail: info@linak.in  
 Web: www.linak.in

Ireland  
 LINAK UK Limited (Ireland)  
 Phone: +44 (0)121 544 2211  
 Fax: +44 (0)121 544 2552  
 +44 (0)796 855 1606 (UK Mobile)  
 +35 387 634 6554 (Rep.of Ireland Mobile)  
 E-mail: sales@linak.co.uk  
 Web: www.linak.co.uk

Italy  
 LINAK ITALIA S.r.l.  
 Phone: +39 02 48 46 33 66  
 Fax: +39 02 48 46 82 52  
 E-mail: info@linak.it  
 Web: www.linak.it

Japan  
 LINAK K.K.  
 Phone: 81-45-533-0802  
 Fax: 81-45-533-0803  
 E-mail: linak@linak.jp  
 Web: www.linak.jp

Malaysia  
 LINAK Actuators Sdn. Bhd.  
 Phone: +60 4 210 6500  
 Fax: +60 4 226 8901  
 E-mail: info@linak-asia.com  
 Web: www.linak.my

Netherlands  
 LINAK Actuator-Systems B.V.  
 Phone: +31 76 5 42 44 40 /  
 +31 76 200 11 10  
 E-mail: info@linak.nl  
 Web: www.linak.nl

New Zealand  
 LINAK New Zealand Ltd  
 Phone: +64 9580 2071  
 Fax: +64 9580 2072  
 E-mail: nzsales@linak.com.au  
 Web: www.linak.com.au

Norway  
 LINAK Norge AS  
 Phone: +47 32 82 90 90  
 E-mail: info@linak.no  
 Web: www.linak.no

Poland  
 LINAK Polska  
 LINAK Danmark A/S (Spółka Akcyjna)  
 Phone: +48 22 295 09 70 /  
 +48 22 295 09 71  
 E-mail: info@linak.pl  
 Web: www.linak.pl

Republic of Korea  
 LINAK Korea Ltd.  
 Phone: +82 2 6231 1515  
 Fax: +82 2 6231 1516  
 E-mail: info@linak.kr  
 Web: www.linak.kr

Slovakia  
 LINAK Slovakia S.R.O.  
 Phone: +421 51 7563 444  
 Web: www.linak.sk

Spain  
 LINAK Actuadores, S.L.u  
 Phone: +34 93 588 27 77  
 Fax: +34 93 588 27 85  
 E-mail: esma@linak.es  
 Web: www.linak.es

Sweden  
 LINAK Scandinavia AB  
 Phone: +46 8 732 20 00  
 Fax: +46 8 732 20 50  
 E-mail: info@linak.se  
 Web: www.linak.se

Switzerland  
 LINAK AG  
 Phone: +41 43 388 31 88  
 Fax: +41 43 388 31 87  
 E-mail: info@linak.ch  
 Web: www.linak.ch - www.fr.linak.ch  
 www.it.linak.ch

Taiwan  
 LINAK (Shenzhen) Actuator systems Ltd.  
 Taiwan Representative office  
 Phone: +886 2 272 90068  
 Fax: +886 2 272 90096  
 E-mail: sales@linak.com.tw  
 Web: www.linak.com.tw

Turkey  
 LINAK İth. İhr. San. ve Tic. A.Ş.  
 Phone: +90 312 4726338  
 Fax: +90 312 4726635  
 E-mail: info@linak.com.tr  
 Web: www.linak.com.tr

United Kingdom  
 LINAK UK Limited  
 Phone: +44 (0)121 544 2211  
 Fax: +44 (0)121 544 2552  
 E-mail: sales@linak.co.uk  
 Web: www.linak.co.uk

## DISTRIBUTORS

Argentina  
 Novotec Argentina SRL  
 Phone: 011-4303-8989 / 8900  
 Fax: 011-4032-0184  
 E-mail: info@novotecargentina.com  
 Web: www.novotecargentina.com

Colombia  
 MEM Ltda  
 Phone: +[57] (1) 334-7666  
 Fax: +[57] (1) 282-1684  
 E-mail: servicioalcliente@memltda.com.co  
 Web: www.mem.net.co

India  
 Mechatronics Control Equipments India Pvt Ltd  
 Phone: +91-44-28558484, 85  
 E-mail: bala@mechatronicscontrol.com  
 Web: www.mechatronicscontrol.com

Indonesia  
 PT. Himalaya Everest Jaya  
 Phone: +6 221 544 8956 /+6 221 544 8965  
 Fax: +6 221 619 1925  
 Fax (Sales): +6 221 619 4658  
 E-mail: hejplastic-div@centrin.net.id  
 Web: www.hej.co.id

Israel  
 NetivTech LTD  
 Phone: +972 55-2266-535  
 Fax: +972 2-9900-560  
 Email: info@NetivTech.com  
 Web: www.netivtech.com

Singapore  
 Servo Dynamics Pte Ltd  
 Phone: +65 6844 0288  
 Fax: +65 6844 0070  
 E-mail: servodynamics@servo.com.sg

South Africa  
 Industrial Specialised Applications CC  
 Phone: +27 011 466 0346  
 E-mail: gartht@isagroup.co.za  
 Web: www.isaza.co.za

United Arab Emirates  
 Mechatronics  
 Phone: +971 4 267 4311  
 Fax: +971 4 267 4312  
 E-mail: mechtron@emirates.net.ae

## Terms of use

LINAK® takes great care in providing accurate and up-to-date information on its products. However, the user is responsible for determining the suitability of LINAK products for a specific application. Due to continual development, LINAK products are subject to frequent modifications and changes. LINAK reserves the rights to conduct modifications, updates, and changes without any prior notice. For the same reason, LINAK cannot guarantee the correctness and actual status of imprinted information on its products.

LINAK uses its best efforts to fulfil orders. However, for the reasons mentioned above, LINAK cannot guarantee availability of any particular product at any given time. LINAK reserves the right to discontinue the sale of any product displayed on its website or listed in its catalogues or in other written material created and produced by LINAK, LINAK subsidiaries, or LINAK affiliates. All sales are subject to the 'Standard Terms of Sale and Delivery for LINAK A/S' available on LINAK websites. LINAK and the LINAK logotype are registered trademarks of LINAK A/S. All rights reserved.