

DESK FRAME 2 (DF2)

Data sheet

DESK FRAME 2 (DF2)

The Desk Frame 2 (DF2) is, as the name indicates, a complete frame from LINAK®. It is characterized by a rethought frame concept, evolved around a new top frame called the Beam. The Beam contains all electronics including the motor and all cable wiring. The DF2 is very fast and intuitive to assemble as the few parts are carefully designed to be either clicked together or attached with only a few screws.

The DF2 has a clean design. The lifting columns have no visible gliding pads and no punch holes in the profiles, and the internal wiring and pre-installed motor in the beam ensure that only the mains cable and the cable to the desk panel are visible. The DF2 is of the well-known LINAK quality and performance similar to other 3-part columns. As standard, the DF2 features the new anti-collision technology, Desk Sensor™ 1, ensuring that collisions with obstacles do not damage the furniture. The DF2 reuses the existing DESKLIFT™ Feet for mounting the lifting columns either on top of or recessed in the foot construction.

The method of packing ensures optimized logistics. All main components are packed individually and the quantity is aligned.



Features:

Beam

- Contains the motor and all electronics
- Colours (all metal parts): Black (RAL 9005), grey (RAL 9006) or white (RAL 9016)
- A telescopic solution – fits table widths 1200 to 1800 mm (adjustable in 50 mm steps)
- Mains voltage 230 V AC, 50 Hz or 120 V AC, 60 Hz
- Oval holes ensure flexibility as regards pre-drilling holes in tabletop
- Desk Sensor 1 (Anti-Collision)
- ZERO™ power: low standby power consumption – only 0.1 W

Columns

- PLUS™ design (no visible gliding pads)
- Easy mounting without any screws - simply snap on to the beam
- Max. load 800 N per column
- Max. speed 38 mm/s unloaded
- 3-part column
- Dimensions column (similar to DL6): 50 x 80 mm (outer profile), 43.5 x 73.5 mm (middle profile) and 37 x 67 mm (inner profile)
See also Dimensional drawings
- Built-in dimension 560 mm / 475 mm (BIFMA)
- Stroke length 650 mm / 665 mm (BIFMA)
- Max bending moment 150 Nm dynamic
- Available in black (RAL 9005), grey (RAL 9006) or white (RAL 9016)

Cantilevers

- Length: 546 mm
- Available for T-desk designs
- Available in black (RAL 9005), grey (RAL 9006) or white (RAL 9016)

Desk panels

- All Desk Panels DPG

Feet

- DESKLIFT™ Feet (DLF) for T-desk designs
- Recessed or on top mounting
- Two lengths (560 mm and 710 mm)
- Available in black (RAL 9005), grey (RAL 9006) or white (RAL 9016)

Usage:

- Can be used for T-desks (central placement of columns)
- Duty cycle: 5% ~ 1 minute continuous use at full load, followed by 19 minutes pause
- Ambient temperature: 10 to 40 °C
- Will be approved according to EN 60335-1 and UL 962
- Compatible with DESKLIFT™ Feet (DLF) for T-desk designs
- Compatible with all Desk Panels DPG

DF2 beam

Ordering example:

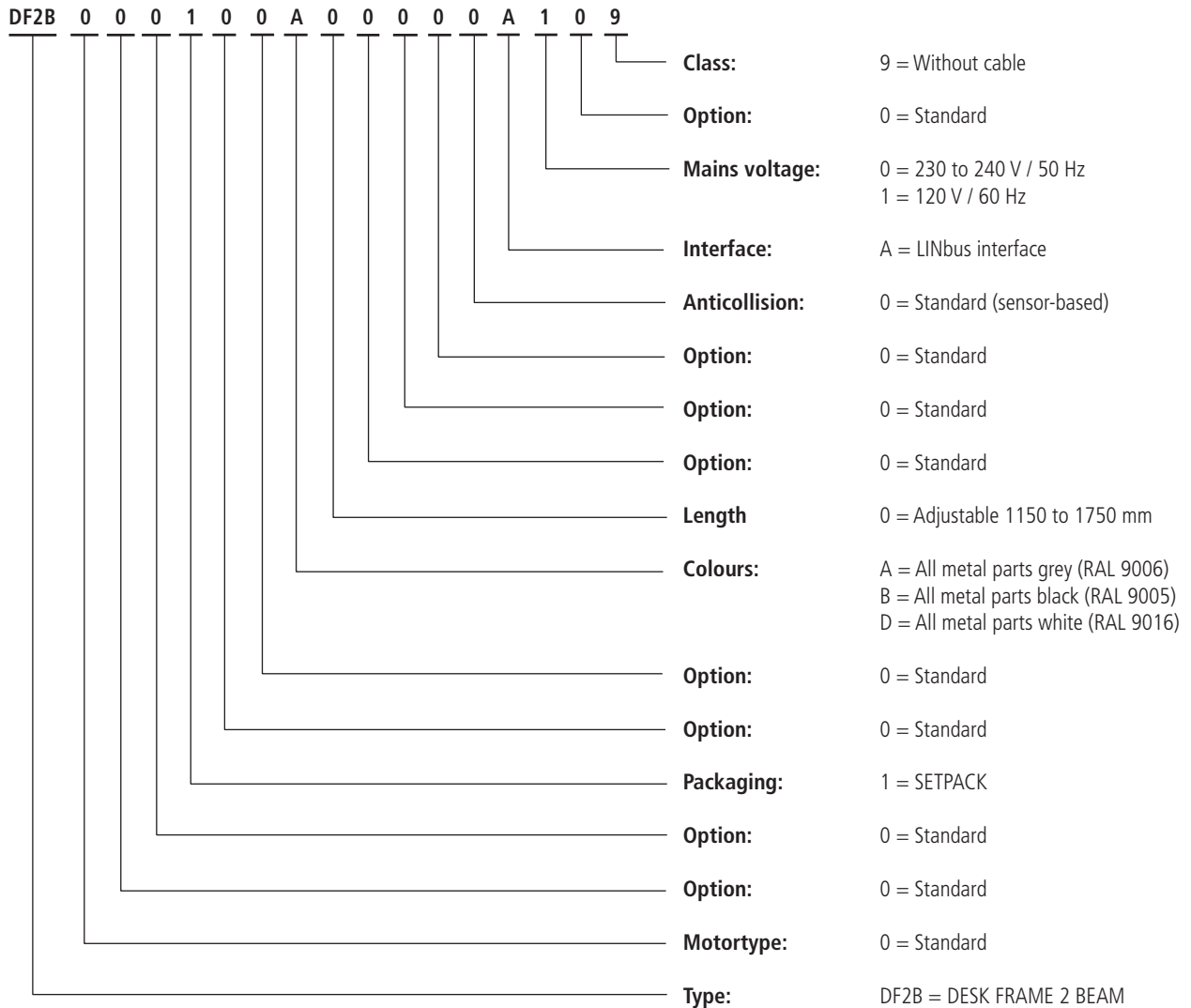

The following item numbers are available:

Item number	Description			
	Mains voltage	Colour	Anti-Collision	Packaging
DF2B00001	120 V AC, 60 Hz	Grey	Desk Sensor™ 1	Set-packed
DF2B00002	120 V AC, 60 Hz	Black	Desk Sensor™ 1	Set-packed
DF2B00003	120 V AC, 60 Hz	White	Desk Sensor™ 1	Set-packed
DF2B00004	230 V AC, 50 Hz	Grey	Desk Sensor™ 1	Set-packed
DF2B00005	230 V AC, 50 Hz	Black	Desk Sensor™ 1	Set-packed
DF2B00006	230 V AC, 50 Hz	White	Desk Sensor™ 1	Set-packed

DF2 columns
Ordering example:

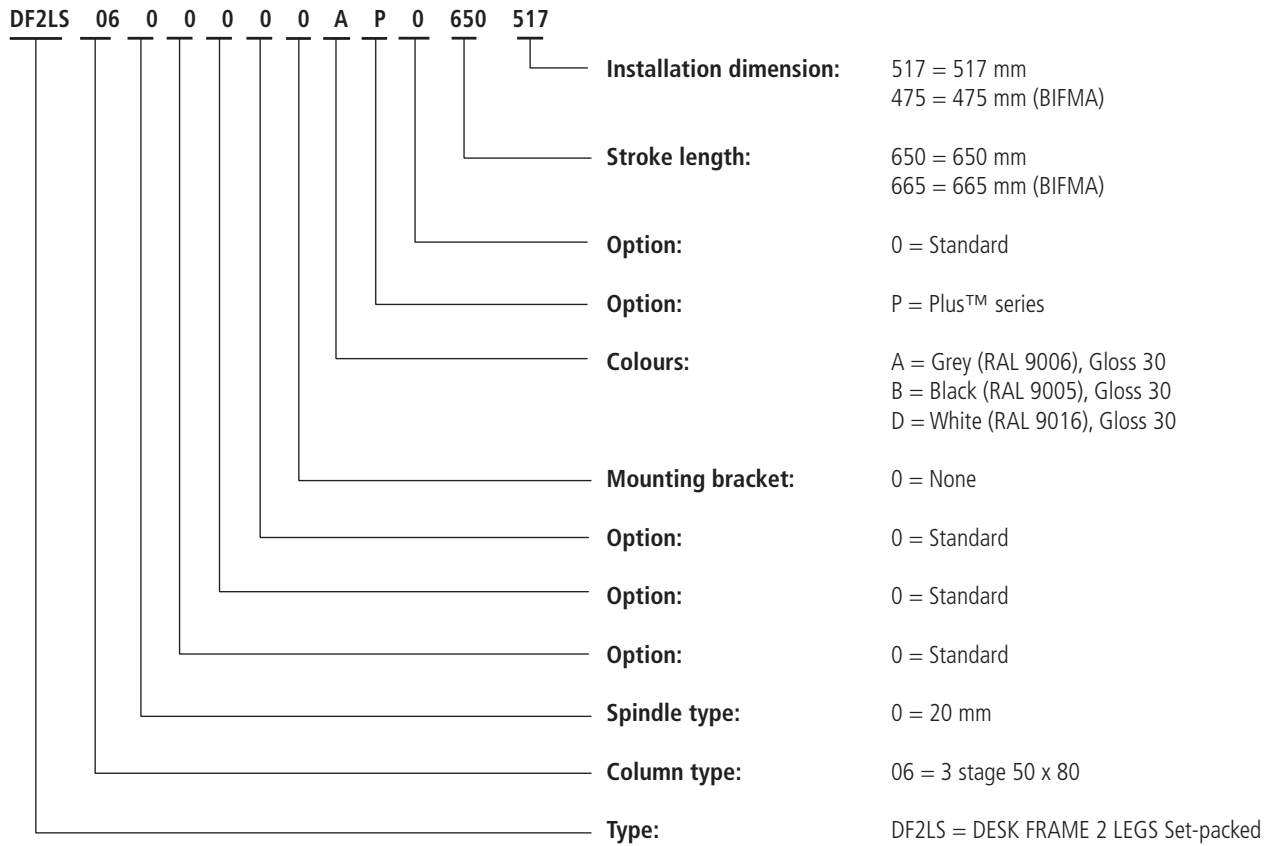

The installation dimensions of the column (517/475 mm) plus the beam correspond to installation dimensions of our standard columns (560/518 mm).

The following item numbers have already been created:

Item number	Description			
	Design	Colour	Dimensions Installation / stroke	Packaging
DF2LS00001	3-stage; 50 x 80 mm	Grey	475 mm / 665 mm	Set-packed
DF2LS00002	3-stage; 50 x 80 mm	Black	475 mm / 665 mm	Set-packed
DF2LS00003	3-stage; 50 x 80 mm	White	475 mm / 665 mm	Set-packed
DF2LS00004	3-stage; 50 x 80 mm	Grey	517 mm / 650 mm	Set-packed
DF2LS00005	3-stage; 50 x 80 mm	Black	517 mm / 650 mm	Set-packed
DF2LS00006	3-stage; 50 x 80 mm	White	517 mm / 650 mm	Set-packed



DF2L in BIFMA version is less stable in the full stroke length compared to a standard DF2L as it has less overlap between the profiles.

DF2 cantilevers, desk panel and cable

Ordering example:

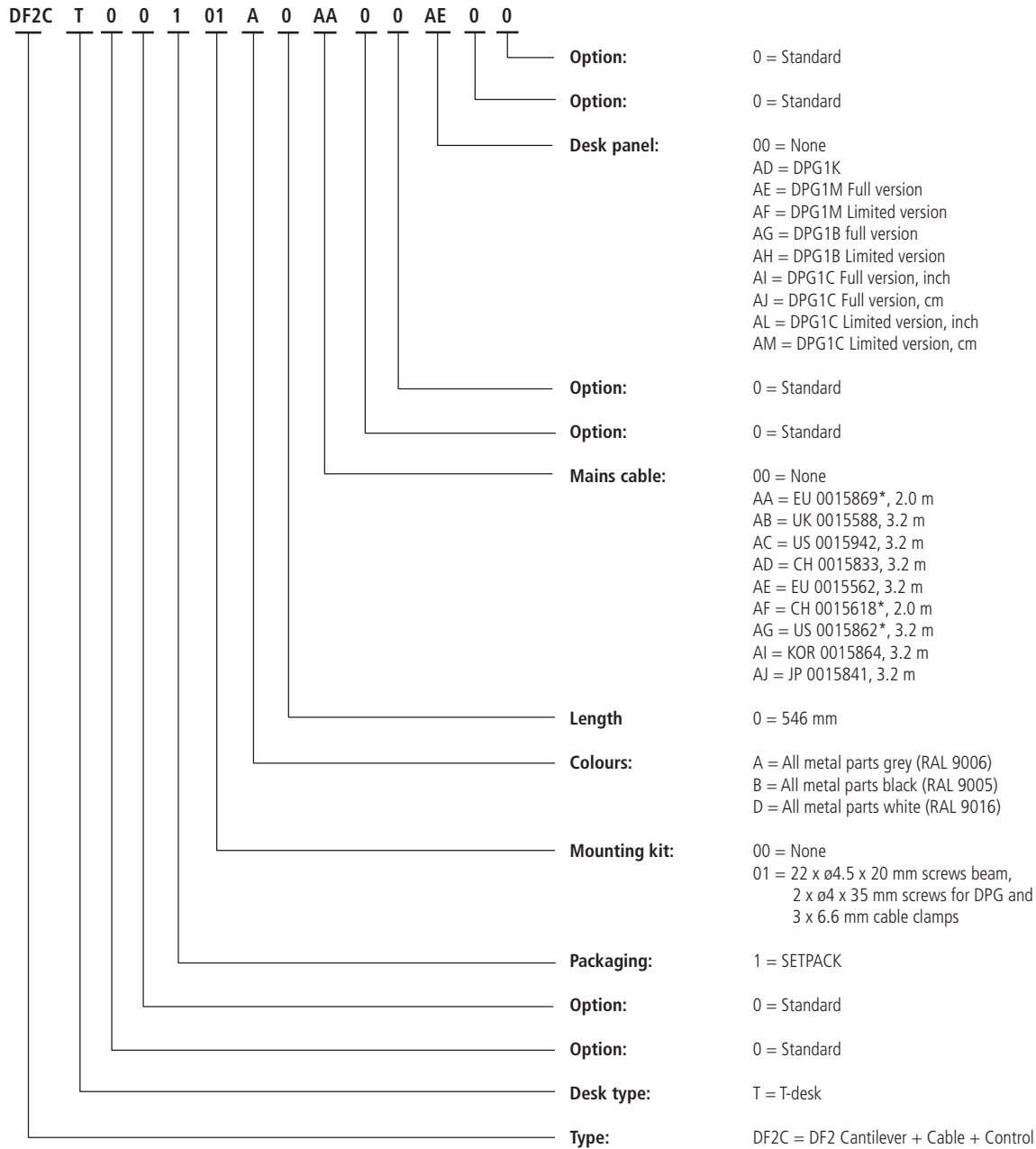

* PVC-Free™

The following item numbers have already been created:

Item number	Description			
	Mains cable	Cantilever colour	Desk panel	Packaging
DF2C00001	US	Grey	DPG1C full version (inch)	Set-packed
DF2C00002	US	Black	DPG1C full version (inch)	Set-packed
DF2C00003	US	White	DPG1C full version (inch)	Set-packed
DF2C00004	EU	Grey	DPG1C full version (cm)	Set-packed
DF2C00005	EU	Black	DPG1C full version (cm)	Set-packed
DF2C00006	EU	White	DPG1C full version (cm)	Set-packed
DF2C00007	None	Grey	None	Set-packed
DF2C00008	None	Black	None	Set-packed
DF2C00009	None	White	None	Set-packed

Dimension drawings

DF2 Beam

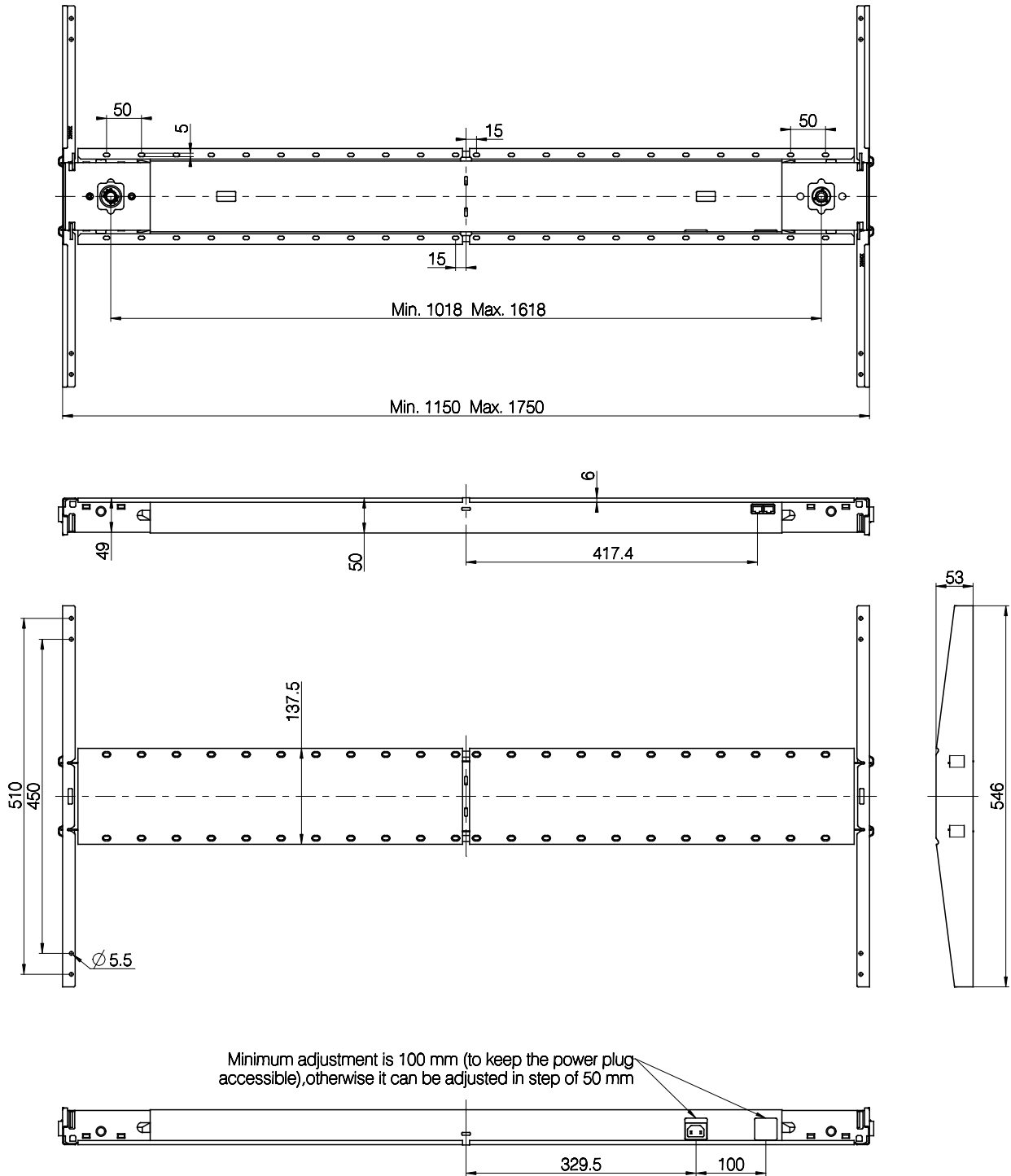

Dimension drawings

DF2 Cantlever

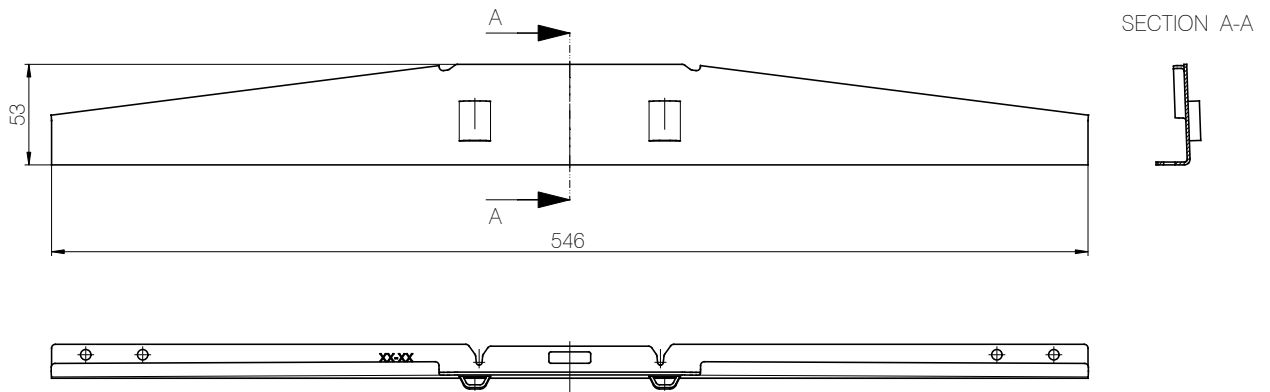
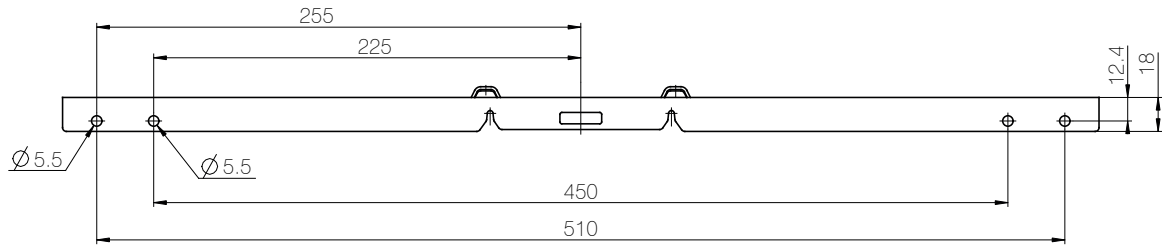

Dimension drawings

DF2 Column (DF2L06)

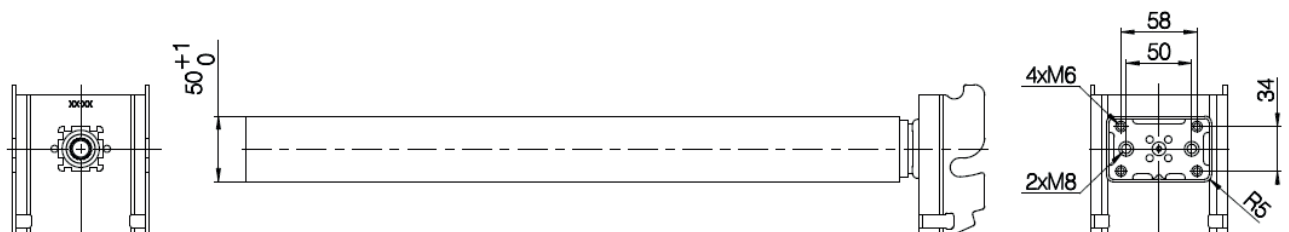
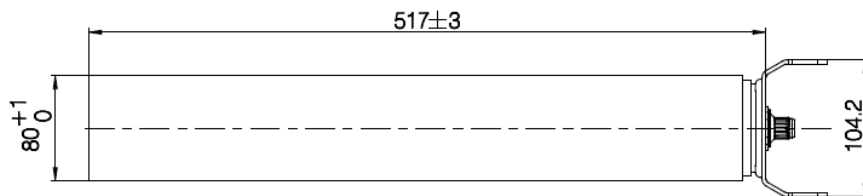
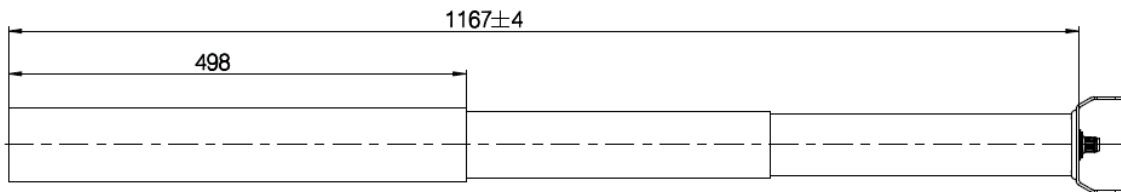

Terms of use

The user is responsible for determining the suitability of LINAK products for specific application. LINAK takes great care in providing accurate and up-to-date information on its products.

However, due to continuous development in order to improve its products, LINAK products are subject to frequent modifications and changes without prior notice. Therefore, LINAK cannot guarantee the correct and actual status of said information on its products.

While LINAK uses its best efforts to fulfill orders, LINAK cannot, for the same reasons as mentioned above, guarantee the availability of any particular product. Therefore, LINAK reserves the right to discontinue the sale of any product displayed on its website or listed in its catalogues or other written material drawn up by LINAK.

All sales are subject to the Standard Terms of Sale and Delivery for LINAK. For a copy hereof, please contact LINAK.