



Actuator LA14  
Relative positioning - Single hall  
*Connection diagram*



# Connection diagram

14XXXXXXXXX0K0X0X=XX0XXXXXXXXX0X

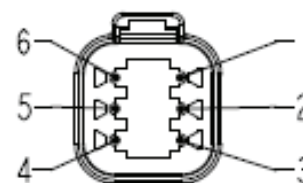
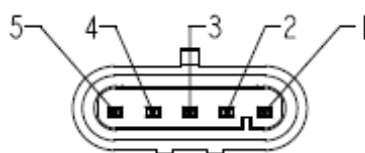
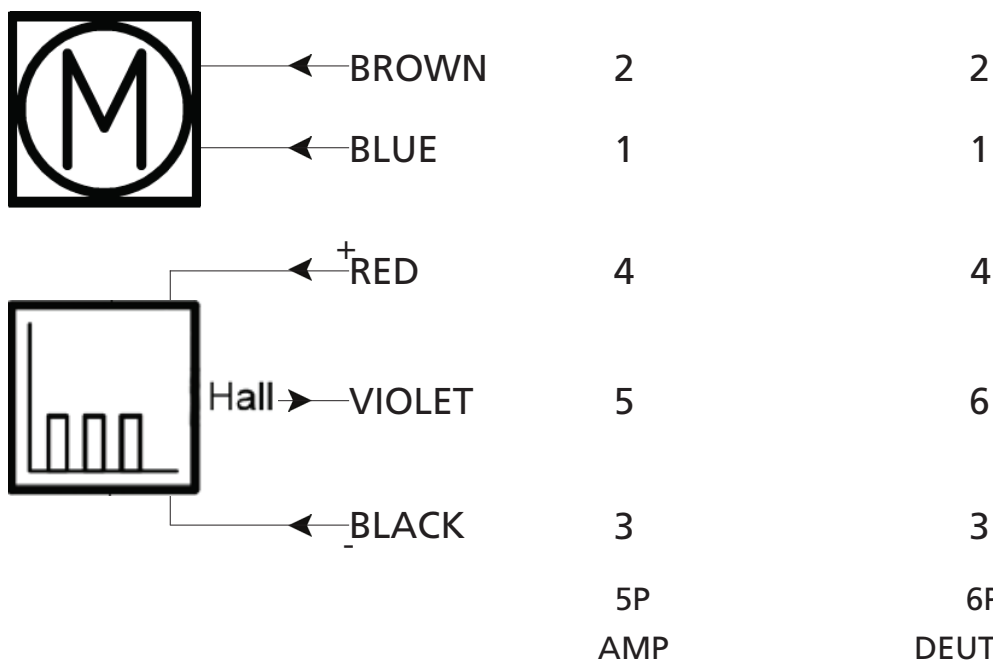
Compliant with:

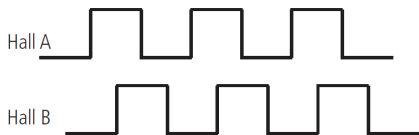

# I/O Specifications

Input/Output	Specification	Comments
Description	The actuator can be equipped with Single hall that gives a relative positioning feedback signal when the actuator moves. See connection diagram, figure above	 Hall
Brown	12 or 24 VDC (+/-)  12 V $\pm$ 20% 24 V $\pm$ 10%	To extend actuator: Connect Brown to positive  To retract actuator: Connect Brown to negative
Blue	Under normal conditions: 12 V, max. 5 A depending on load 24 V, max. 2,5 A depending on load	To extend actuator: Connect Blue to negative  To retract actuator: Connect Blue to positive
Red	Signal power supply (+) 12-24 VDC	Current consumption: Max. 40 mA, also when the actuator is not running
Black	Signal power supply GND (-)	
Green	Not to be connected	
Yellow	Not to be connected	
Violet	Single Hall output (PNP) Movement per Single Hall pulse: LA14020 Actuator = 0.2 mm per pulse LA14040 Actuator = 0.4 mm per pulse Frequency is 14-26 Hz on Single Hall output depending on load. Overvoltage on the motor can result in shorter pulses.	Output voltage min. $V_{IN} - 2\text{ V}$ Max. current output: 12 mA Max. 680 nF N.B. For more precise measurements, please contact LINAK A/S. Low frequency with a high load. Higher frequency with no load.
	Input:   Hall A Hall B	Single hall output:     Micro - Processor
White	Not to be connected	

---

**Terms of use**

LINAK® takes great care in providing accurate and up-to-date information on its products. However, the user is responsible for determining the suitability of LINAK® products for a specific application.

Due to continuous development, LINAK products are subject to frequent modifications and changes. LINAK reserves the rights to conduct modifications, updates, and changes without any prior notice. For the same reason, LINAK cannot guarantee the correctness and actual status of imprinted information on its products.

LINAK uses its best efforts to fulfill orders. However, for the reasons mentioned above, LINAK cannot guarantee availability of any particular product at any given time. LINAK reserves the right to discontinue the sale of any product displayed on its website or listed in its catalogues or in other written material created and produced by LINAK, LINAK subsidiaries, or LINAK affiliates.

All sales are subject to the 'Standard Terms of Sale and Delivery for LINAK A/S'. Please contact LINAK for a copy.