

Focus on Building Louvres

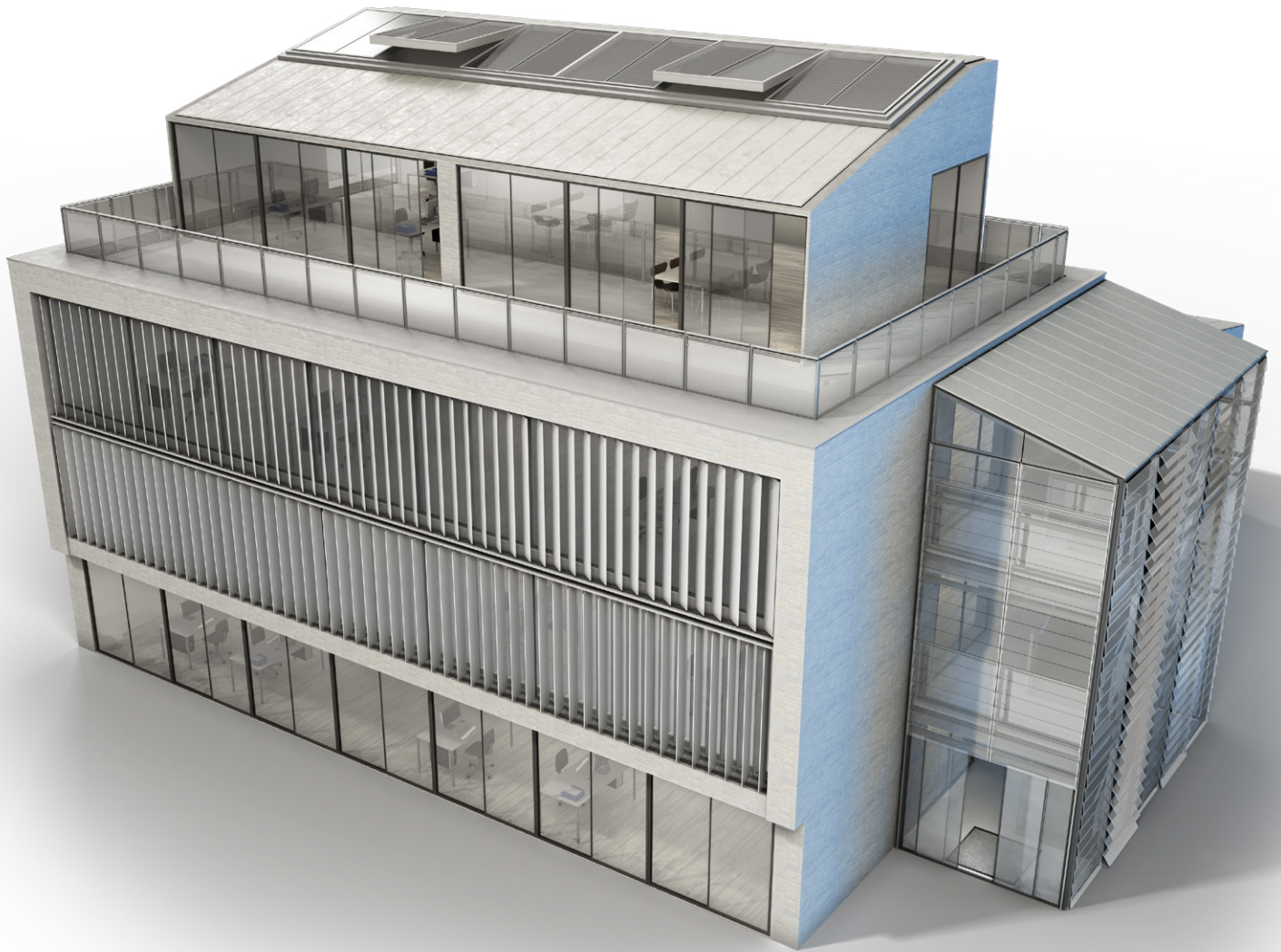

Improve energy efficiency and indoor climate with building louvres

There is an increasing focus on energy conservation in domestic and commercial buildings. In some countries, governments provide tax concessions for buildings with high energy ratings. Therefore, there is an increased demand for use of natural light, which means more use of glass. And to utilise this, it becomes necessary to control the level of light and heat entering the building.

Building louvre systems provide better indoor climate and better control of temperature with less use of expensive heating or cooling systems. Fully automated louvres driven by LINAK® actuator solutions function as natural ventilation systems, natural cooling systems as well as complete solar shading systems. LINAK actuators can be incorporated into the design of the building and they have the ability to interface with building management control systems.

Aluminium louvres can control and regulate the heat load and minimise exposure from the sun by providing solar shading. Glass louvres can improve building ventilation by letting in fresh air on warm days.

The use of LINAK® actuator solutions to adjust louvres as well as entire building automation systems, results in an overall energy reduction with use of fewer resources for both heating and cooling.

LINAK offers service
worldwide

Please contact your local LINAK office with
your enquiry



What LINAK actuators do for building louvres

LINAK® actuators can be used to operate aluminium louvres mounted externally on the building. These louvres serve the purpose of determining how much light should enter the building. Likewise, LINAK actuators can be used to operate glass louvres for better ventilation and natural cooling as well as for view purposes, allowing for a clear uninterrupted view of the scenery.

The louvres can be controlled by an electrically operated switch mounted on the inside wall of the building.

This allows staff to adjust the louvre, and accordingly the level of light or air entering the building, depending on the time and/or temperature of the day.

The use of LINAK actuator solutions to adjust louvres as well as entire building automation systems, results in an overall energy reduction with use of fewer resources for both heating and cooling. With a fully automated system, the adjustment of louvres is easy and quick ensuring a better indoor climate.

Solar shading and heat control with automatic opening and closing of aluminium louvres in rooftop windows

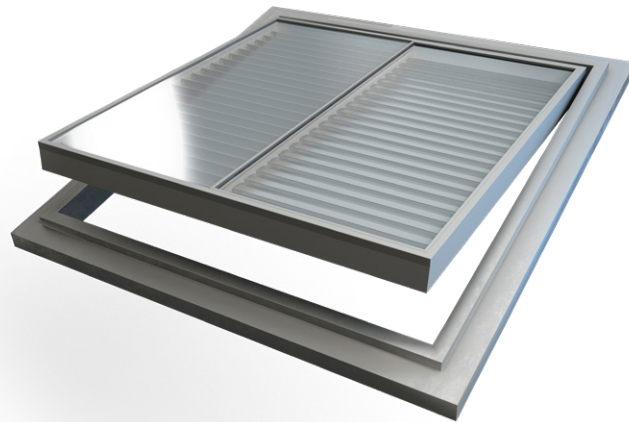

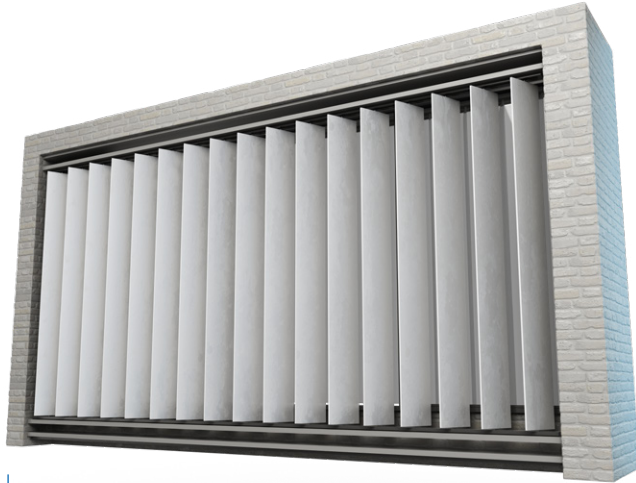

Actuator solutions ensure easy and quick opening and closing of aluminium louvres for solar shading



Natural ventilation with smooth and quick controlling of glass louvres, driven by LINAK actuator solutions

Explore the rich technology behind actuators



At the Actuator Academy™, you will find a library of videos and information about actuator components, actuator testing, and intelligent actuator control.

Find out what you should expect of a good industrial actuator, what affects its performance and efficiency, and how to best utilise your linear motion actuator.

We hope to inspire you and ultimately make you wiser on the moving electric revolution we are all part of.

Happy exploring!

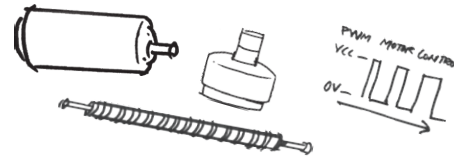
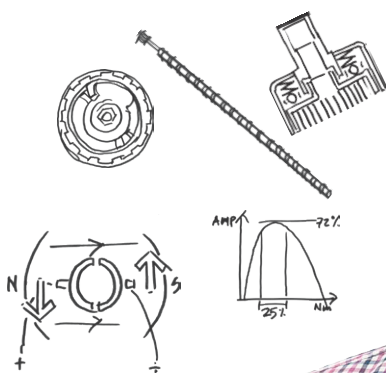

Check out the
Actuator Academy

[LINAK.COM/
ACTUATOR-ACADEMY](http://LINAK.COM/ACTUATOR-ACADEMY)

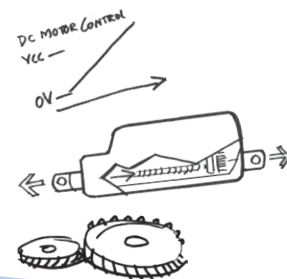

Smart movement for building louvres

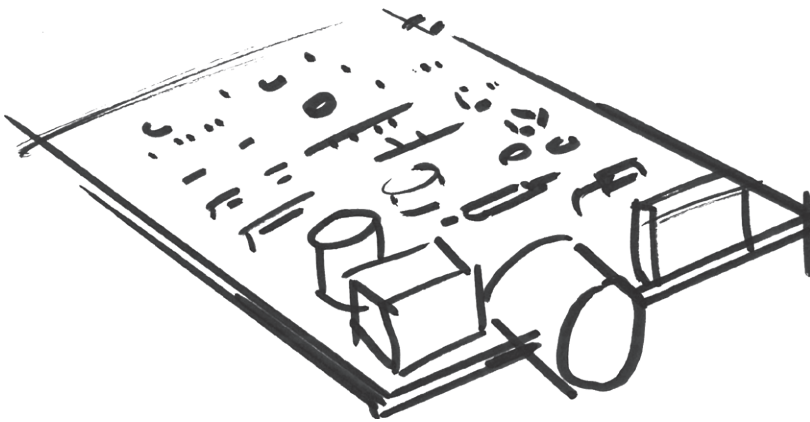

A LINAK® IC actuator with built-in controller reduces the number of external components and the need for a third-party supplier for power electronics.

It also offers a comprehensive range of interfaces and gives you access to productivity enhancing data - all delivered by a single supplier you can trust.

By helping you move smarter at every stage of your application process, from development, installation and integration to tailored movement and improved productivity, our IC actuators add value across the board.

IC INTEGRATED CONTROLLER™

Choosing an IC actuator for your application is a smart move in many ways:

- Reduced complexity for faster development and production
- Flexible integration with a variety of industrial interfaces
- Data monitoring that minimise downtime and boost productivity
- Benefit from one single supplier



For more information on IC, please visit LINAK.COM or scan the QR code.

Actuators for building louvres

LINAK® industrial actuators offer a versatile array of movement solutions for building louvres.

With **thrusts up to 15,000 N, max speeds up to 160 mm/s, and strokes between 20 and 999 mm**, the actuators are highly adaptable for a wide variety of applications.

Industrial actuators with **heavy-duty aluminium housings** are very suitable for use in corrosive environments. Having been thoroughly salt spray and chemical resistance tested and approved for ratings up to **IP66 and IP69K static**, these actuators will work reliably for years, even when exposed to salt, water, wind, and sun.

Operating temperatures between -40°C to +85°C make them fit for work in numerous settings.

Actuator LA37



Actuator LA36



Actuator LA33



Actuator LA25

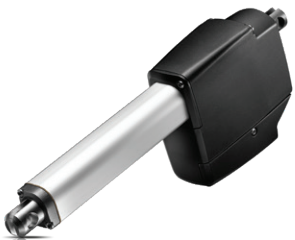

Actuator LA23



Actuator LA14



Actuator LA12



Testing programme

In each industrial application, the actuator is just one component of many, but at LINAK® we fully appreciate that it is of utmost importance to you and your customers. Not a single actuator leaves the factory until it has undergone a 100% function test.

Depending on the actuator type, various tests have been carried through. Please consult your local LINAK office or take a look at the actuator data sheet in question to get a thorough test overview.

This is your guarantee that a solution based on LINAK TECHLINE electric actuator systems is a solution that will work reliably for years and years.

“Our actuators must never malfunction. Therefore, it is important that all our products are tested inside and out, and to the extreme in a wide range of tests.”

- Claus H. Sørensen, Director R&D

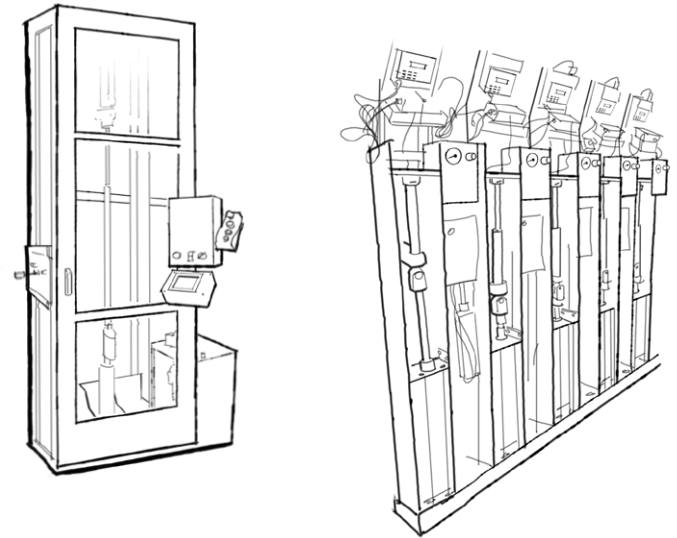

Climatic tests:

In the climatic test the actuators are tested to operate in extreme temperatures as well as to endure rapid changes in temperature. In a dunk test, the actuators have to withstand repeating temperature fluctuations between +85°C to -40°C and still maintain full functionality and ingress protection.

EN60529-IP6X	- Dust
EN60529-IPX6	- Water
ISO16750- IP69K	- High pressure cleaning
IEC60068-2-3	- Moisture storage
IEC60068-2-30	- Operation in moisture
ISO16750-4:2010	- Dunk test
EN60068-2-52	- Salt spray
BS7691 Section 6.11.2.4	- Chemicals

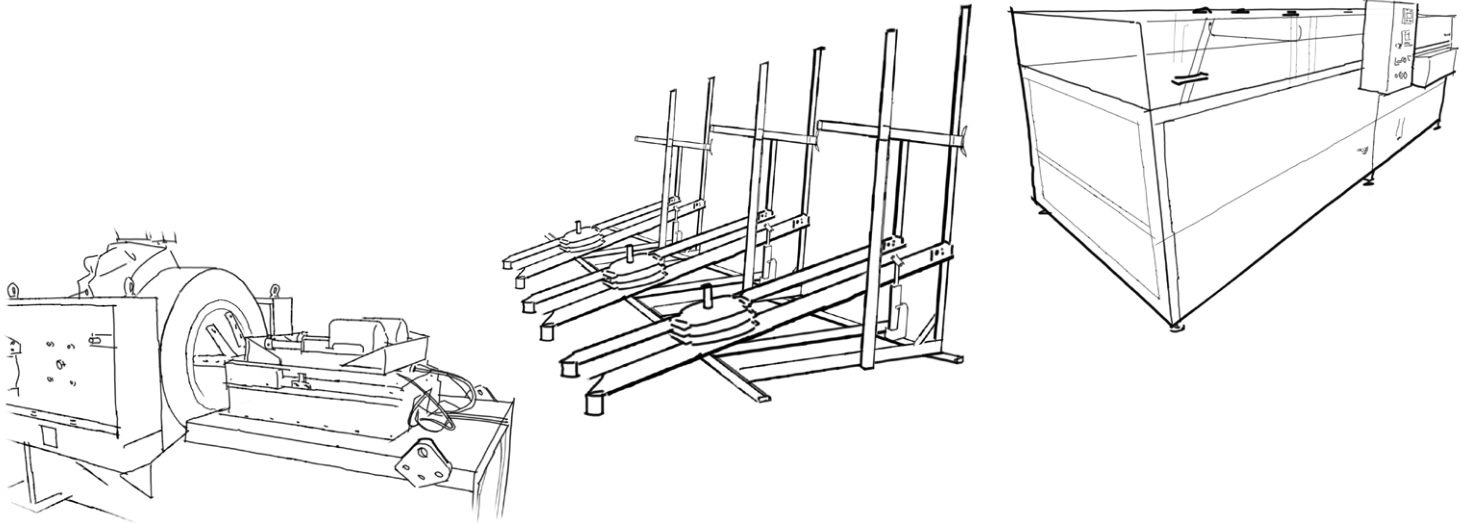

Electrical tests:

All electrical parts are tested i.e. power supply, power and signals cables, control signals etc. Electrical immunity is tested according to industrial standards i.e. for radio noise, electrical discharge and burst.*

EN/IEC 61000-6-4	- Generic standard emission industry
EN/IEC 60204	- Electrical equipment of machinery
EN 50121-3-2	- Railway applications - Rolling stock apparatus
94/25/EC	- Recreational crafts directive
EN/ISO 13766	- Earth moving machinery
EN/IEC 61000-6-2	- Generic standard immunity industry
2004/104/EC	- Automotive Directive
EN/ISO 14982	- Agricultural and forestry machines
EN/ISO 13309	- Construction machinery

* These tests do not apply to third party products!

Mechanical tests:

Vibration: The actuator must withstand continuous vibration in three directions.

Shock: The shock test puts the actuator through 3 shocks of up to 50 G in each of six directions.

Bump: The actuator receives bumps of up to 30 G in each of six directions several hundred times.

EN60068-2-64 (Fh) - Random vibration

EN60068-2-27 (Ea) - Shock

EN60068-2-29 (Eb) - Bump

Find out more about how we test actuators to the extreme:

linak.com/segments/techline/tech-trends/testing/





For further information, please visit our website:
LINAK.COM/BUSINESS-AREAS/SOLAR-SHADING/LOUVRES/

LINAK® accepts no responsibility for possible errors or inaccuracies in catalogues, brochures, and other material. LINAK reserves the right to change its products without prior notice. LINAK cannot guarantee product availability and reserves the right to discontinue the sale of any product. User is responsible for determining the suitability of LINAK products for a specific application. All sales are subject to the 'Standard Terms of Sale and Delivery', available on LINAK websites.

LINAK and the LINAK logotype are registered trademarks of LINAK A/S. All rights reserved.



QUALITY

Built by market leading experts, using state-of-the-art technologies and perfected production methods, you can expect the same quality worldwide.



INNOVATION

Innovation is in our core. We take the lead and have the courage to make it real.



RESPONSIBILITY

We are responsible in what we do – towards customers, employees and environment. Creating trust is a natural part of who we are.



**LOCAL
& GLOBAL**

From global presence to local understanding. We believe in world-wide support and being close to our customers.